

3-21-2013

Urgent Aeromedical Evacuation Network Capacity Planning

Scott C. Finkbeiner

Follow this and additional works at: <https://scholar.afit.edu/etd>

Part of the [Health and Medical Administration Commons](#), and the [Other Operations Research, Systems Engineering and Industrial Engineering Commons](#)

Recommended Citation

Finkbeiner, Scott C., "Urgent Aeromedical Evacuation Network Capacity Planning" (2013). *Theses and Dissertations*. 962.
<https://scholar.afit.edu/etd/962>

This Thesis is brought to you for free and open access by the Student Graduate Works at AFIT Scholar. It has been accepted for inclusion in Theses and Dissertations by an authorized administrator of AFIT Scholar. For more information, please contact richard.mansfield@afit.edu.



**URGENT AEROMEDICAL EVACUATION
NETWORK CAPACITY PLANNING**

THESIS

Scott C. Finkbeiner, 2nd Lieutenant, USAF

AFIT-ENS-13-M-04

**DEPARTMENT OF THE AIR FORCE
AIR UNIVERSITY**

AIR FORCE INSTITUTE OF TECHNOLOGY

Wright-Patterson Air Force Base, Ohio

APPROVED FOR PUBLIC RELEASE; DISTRIBUTION UNLIMITED.

The views expressed in this thesis are those of the author and do not reflect the official policy or position of the United States Air Force, Department of Defense, or the United States Government. This material is declared a work of the U.S. Government and is not subject to copyright protection in the United States.

AFIT-ENS-13-M-04

**URGENT AEROMEDICAL EVACUATION NETWORK CAPACITY
PLANNING**

THESIS

Presented to the Faculty

Department of Operational Sciences

Graduate School of Engineering and Management

Air Force Institute of Technology

Air University

Air Education and Training Command

In Partial Fulfillment of the Requirements for the
Degree of Master of Science in Operations Research

Scott C. Finkbeiner, BS

2nd Lieutenant, USAF

March 2013

APPROVED FOR PUBLIC RELEASE; DISTRIBUTION UNLIMITED

AFIT-ENS-13-M-04

URGENT AEROMEDICAL EVACUATION NETWORK CAPACITY PLANNING

Scott C. Finkbeiner, BS
2nd Lieutenant, USAF

Approved:

Dr. Jeffery K. Cochran (Advisor)

date

Dr. J. O. Miller (Co-Advisor)

date

Abstract

Aeromedical Evacuation (AE) has been steadily utilized during Operation Iraqi Freedom and Operation Enduring Freedom. AE is a global enterprise. The current structure of AE is facing changes as forces scale down from operations in Iraq and Afghanistan. AE will, however, continue to be important in its domestic use in the continental USA (CONUS). Current practice is to pull aircraft (e.g. C-17, C-130 or KC-135) from their normal operations to meet Urgent and Priority patient needs when local alternatives are infeasible. An alternative to the current system would be having a centralized "bed-down" location for AE operations that would house dedicated aircraft as well as AE personnel. In this thesis, a hybrid queuing and discrete-event simulation approach is used to determine how many aircraft are needed for a given level of AE patient care and an integer programming model is used to locate aircraft within the provider network. The high costs associated with operating current aircraft drive this research to look for solutions that better represent the future of Urgent and Priority patient movement operations whether CONUS or global.

Acknowledgments

I am grateful to my sponsors, Col Faubion and Mr. Hannan for taking the time to teach me about AE. Also, the coordination of visits around Scott AFB, frequent clarifying questions and ensuring I had the necessary resources propelled this work through to completion.

It has been an honor for me to have worked with Dr. Cochran. My initial expectations have been exceeded by his fervent ability to guide an advisee. He fueled the total experience and without doubt advanced my academic level in Operations Research.

Finally, this thesis would not be possible without the support of my wife (and luck charm) as well as my daughter whose positive energy is contagious even on the dreariest Ohio day.

Table of Contents

	Page
AIR FORCE INSTITUTE OF TECHNOLOGY	i
Abstract	iv
Table of Contents	vi
List of Tables	vii
List of Equations	ix
I. Introduction	1
II. Literature Review.....	2
History of AE.....	2
Defining AE.....	5
Past AFIT Research	15
Research Questions.....	19
III. Methodology	21
Location	22
Queueing.....	32
Simulation.....	33
Notional Simulation Model	36
Design of Experiment	43
IV. Analysis and Results	44
V. Conclusion, Recommendation and Future Study.....	51
Future Work.....	52
VI. Appendix.....	54
Quad Chart.....	64
Bibliography	65

List of Tables

	Page
Table 1: AE Breakdown.....	5
Table 2: Summary of 1976 Article	8
Table 3: Evaluation Measures.....	16
Table 4: Base Locations and Populations	23
Table 5: Summary of Regions	24
Table 6: Summary of IP constraints.....	26
Table 7: Nearest Locations to WMC	27
Table 8: Distances to Patient.....	28
Table 9: Average Distances to Patient	28
Table 10: Distances to EPC	28
Table 11: Average Distances to EPC.....	29
Table 12: Mission Distances.....	29
Table 13: AE Data Utilized.....	30
Table 14: M/M/1 Results	32
Table 15: Queueing Utilization Table.....	33
Table 16: AMC Redistribution Costs 2011	36
Table 17: C-37B Example Costs.....	36
Table 18: Redistribution Mileage	36
Table 19: Components of Simulation Model.....	38
Table 20: Service Times	39
Table 21: MSE	40
Table 22: Distribution Comparison	41
Table 23: DOE inputs	43
Table 24: DOE results.....	44
Table 25: JMP results.....	45
Table 26: Data for Developing Costs.....	47
Table 27: DOE Flying Hours.....	47
Table 28: DOE PMR Costs.....	48
Table 29: DOE Redistribution Costs	48
Table 30: DOE Total Costs.....	49

List of Figures

	Page
Figure 1: C-9A Nightingale	2
Figure 2: Diamond's AE Chart	3
Figure 3: AE Timeline	4
Figure 4: C-17, C-130 and KC-135	4
Figure 5: Army Field Manual Diagram	6
Figure 6: Map of Regions from 1976 Article	9
Figure 7: AFTTP 3-42.5 Flowchart	11
Figure 8: AFTTP 3-42.5 Visual Diagram	12
Figure 9: DODI 6000.11 Decision Flowchart.....	14
Figure 10: Methodology Chart.....	21
Figure 11: CONUS AFB Locations	22
Figure 12: Redistribution Visual Aid.....	35
Figure 13: Simulation Model	37
Figure 14: Input Analyzer Results	41
Figure 15: Simulation Overview.....	42
Figure 16: DOE Utilization Results.....	46
Figure 17: US Navy's C-40A Clipper	52

List of Equations

	Page
Equation 1: Cost Difference.....	13
Equation 2: Wilhelm's Value Function	16
Equation 3: Whetstone's Objective Function	18
Equation 4: Location IP	25
Equation 5: WMC Formulation	27
Equation 6: Mission Times	31

I. Introduction

The proposed topic aims at giving Air Mobility Command (AMC) insight into the future of Urgent and Priority AE operations within the continental US. The current flexible system operates well but isn't tailored for small scale AE needs. The financial future of the Air Force also dictates the testing of other alternatives. There exists a need to evaluate alternatives that would save the AF while at the same time provide the equivalent level of care. An alternative to pulling aircraft (C-17, C-130 and KC-135) to meet AE needs would be having a centralized hub with designated aircraft. Specifically testing out what the potential benefits of having an AF owned asset or a contracted one would be. To do so, several angles to the alternatives will be tested out.

Some of the data required would be flying hour cost, speed of aircraft and also the frequencies of Urgent and Priority demands. Urgent patients are emergency cases that must be moved to save life or limb, or prevent complications of serious illness (Army Medical). Priority patients require prompt medical attention that cannot be acquired locally and must be delivered with least possible delay within 24 hours. The work will focus on the Continental US Urgent and Priority AE mission. Several alternatives will be developed to make comparisons to the current AC being utilized. To model alternatives, several Operations Research disciplines will be used.

II. Literature Review

History of AE

AE has been an evolving process since the inception of the idea to use airplane for transporting patients. In 1910, Capt Gosman and 1st Lt Rhoades had the idea however not the support of the Army; that would come in 1918 when the director of the Army Air Service ordered every Army airfield to have their own air ambulance (Elliot, 2010). Soon, in 1922, the French Army air evaced “over 2200 during the Riffian war in Morrocco” (Austin, 2002). The idea of medical practioners onboard started with the formation of the Australian Aerial Medical Services (AAMS) in 1934 (Royal Flying Doctor Service, 2013). During the course of WWII 1.34 million air evacuations were carried out by all sides (Nanney, 1998). During the Korean War, Combat Cargo transported 311,673 wounded personnel within theater and Military Air Transport Service (MATS) sent back 43,196 to the US (National Museum of the USAF). In fiscal year (FY) 1966, MATS was recorded as performing 97,422 AE mission in the US (including trips from overseas hospitals to US aerial ports) in a Airlight Service Management Report (Reiter, 1993).



Figure 1: C-9A Nightingale

In 1968 the first “AE specialized” C-9A was delivered to Military Airlift Command (MAC) which would be the AE workhorse for more than 30 years (Air Mobility Command Museum). During the Vietnam War, MAC evacuated 7,436 patients out of Vietnam in March 1969 alone (Clingman, 1989). The entire duration of the Gulf War had 12,500 successful transports utilizing converted cargo AC (Howell & Brannon, 2000). AE missions within the continental US were at 70,000 as of 1995 (Diamond, 2003) however the complete implementation of TRICARE (military healthcare program) in May 1997 would drop the number (Health, Education, and Human Services Division, 1995).

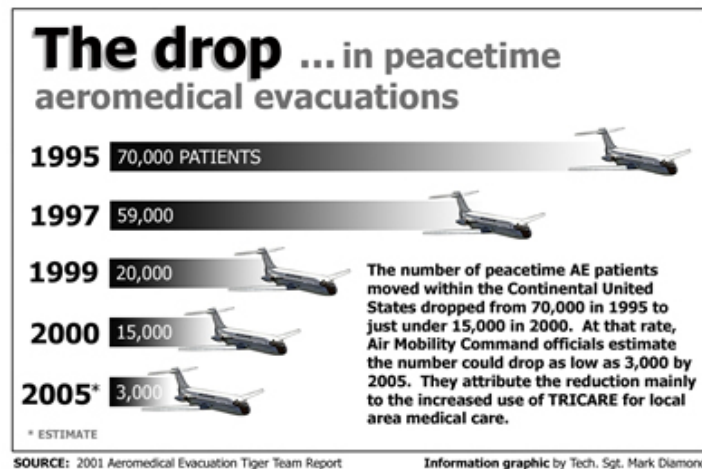

Figure 2: Diamond’s AE Chart

Numbers of AE missions dropped down to 20,000 in 1999 and 15,000 in 2000 due to the TRICARE’s network of local providers capturing cases that in the past would require AF AE (Diamond, 2003). The need for a dedicated AC to blanket the total AE mission ceased. With TRICARE fully online and the C-9A aging, Air Mobility

Command (AMC) shifted from a “capacity-based system” to a “requirements-based system” and retired the C-9A on July 23rd 2003.

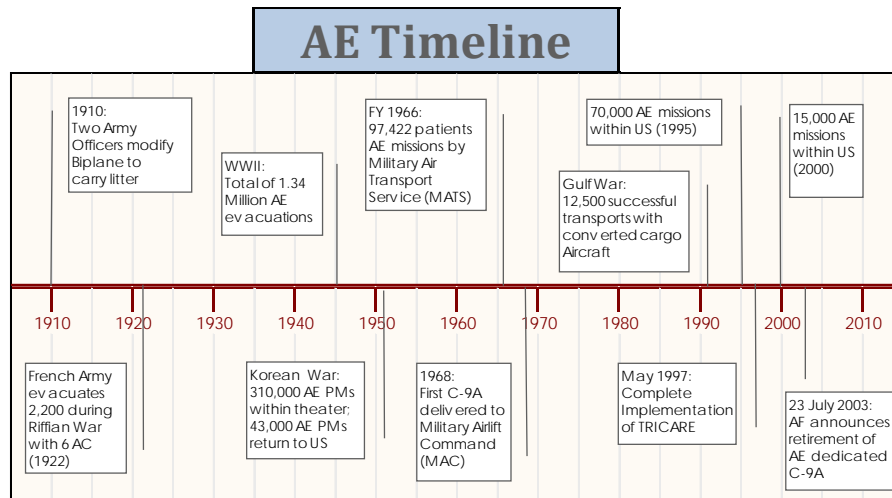

Figure 3: AE Timeline

The new “requirements-based system” would essentially pull either a C-17, C-130 or KC-135 (pictured in that order) and equip it with the appropriate equipment and personnel. This system has been a great asset for recent conflicts; in 2010 AE was delivering patients from Afghanistan and Iraq in 3 days which is 7 days faster than Operation Desert Storm and 40 days faster than the Vietnam War (AFA News, 2010). The current set-up is ideal for times of conflict, especially since the AC used are adaptable to the unique operational demands of forward AE missions (both C-130 and C-17 can utilized un-improved runways).



Figure 4: C-17, C-130 and KC-135

The C-17 (pictured left), the typical AE airframe for inter-theater transportation can hold up to 36 litter and 54 ambulatory patients (Guerdan, 2011). The C-130 (pictured center), best equipped for intra-theater demands can accommodate up to 74 litters and finally the KC-135 (pictured right), known for its longer range can handle up to 15 litters and 8 ambulatory patients. It must be pointed out that these capacities are just one of many configurations. These aircraft are suited well for missions that can deliver either cargo, fuel or a large volume of patients.

Defining AE

AE can be broken into three categories as from an article of the American Journal of Medicine (Bruce R. Guerdan, 2011).

Table 1: AE Breakdown

	Case-Evac	Medevac	Air-Evac
Typical Branch	Army, Marines	Army	Air Force
Type of Transport	Any means	Ground or Rotary Wing AC	Fixed Wing AC
Typical Movement	Point of injury to staging area	Staging area to field hospital	Field hospital thru to endpoint of care
Level of Care	None to Minimum	Minimum	High-level specific to patient needs

Casualty Evacuation (Case-Evac) supports patients from the initial point of injury (POI) which is currently accomplished using AC like the MV-22 Osprey. A Naval Post-Graduate School (NPS) thesis looked at unmanned aerial systems (UAS) using simulation to determining optimal factors like number of litters per system (Featherstone, 2009). Another recent study from the Journal of Defense Modeling and Simulation (JDMS) utilized simulation to test the MV-22 against the same nascent technology of

autonomous aircraft or UAS (Anderson, Konoske, & Davis, 2010). An article, again from JDMS, looked at how different methods like Case-Evac from the POI affected soldier mortality rates (Mitchell, Parker, Galarneau, & Konoske, 2010).

Medical Evacuation (Medevac), primarily a mission of Army helicopters, is best defined as patient/casualty evacuation when time is sensitive (O'Shea, 2011). The following figure from the Army Field Manual (FM) summarizes their area of interest (Army, 2009).

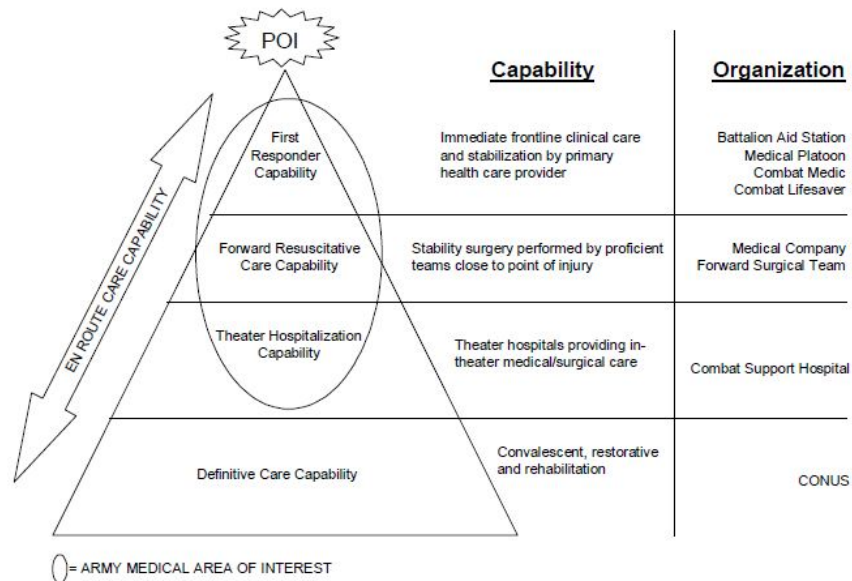

Figure 5: Army Field Manual Diagram

Helicopter Medevac came to maturity during the Vietnam War being known as DUSTOFF (from literally dusting of those to be evacuated by a rotary wing AC). A 1990 US Army War College project advocated for medical assets to be dedicated to Medevac missions due to their inherent time sensitive nature (Miles, 1990). A study of past Medevac missions stressed for the future helicopter units to know the lessons learned from evacuation efforts during the Korean and Vietnam War (Howard, 2003).

Operations during current times feature single units performing over 1500 Medevac missions in a year like in Operation Iraqi Freedom (OIF) II (Kneeland, Risio, Fulton, & Goodman, 2005). An article from JDMS featured work done using stochastic optimization goal-planning to determine the minimum number of helicopters in-theater to meet demand while minimizing their vulnerability to attack (Bastian, A Robust, Multi-criteria Modeling Approach for Optimizing Aeromedical Evacuation Asset Emplacement, 2010). Another JDMS article presented the results of a DOTMLPF (Doctrine, Organization, Training, Maintenance, Leadership, Personnel, and Facilities) assessment which found the problem areas of Medevac to be maintenance and manpower (Bastian, Fulton, Mitchell, Pollard, & Wilson, 2012).

Aeromedical Evacuation (Air-Evac or AE) has had many aspects researched over the years. AF operations on average encompass the bottom two items of Figure 4, Theater Hospitalization Capability and Definitive Care Capability. Several studies focus on patient safety like finding that obstetrics patients can be evacuated (air) at any gestational period despite USAF policy that doesn't recommend it after 34 weeks (Connor & Lyons, 1995). Others focus on inflight oxygen saturation decrements (Bendrick, Nicolas, Krause, & Castillo, 1995) or the feasibility of ear acupuncture inflight for pain management of which posted positive results (Walter, York, Thati, Niemtzow, & Burns, 2012). A recent study focused on determining when a patient with a traumatic brain injury is safe to fly (Goodman, et al., 2010). Simulated AE using mice found that hemorrhagic shock did not worsen systemic inflammation or organ injury compared to controls (Makley, et al., 2012). Another work on Operation Desert Storm found designated AE crews important to mission success (Mabry, Munson, &

Richardson, 1993). Biosafety containment during AE with the Aeromedical Isolation Team is described in detail in a 1999 report (Christopher & Eitzen Jr., 1999) and in a 2000 report, AE is deemed safe and effective for contagious biological warfare patients (Withers & Christopher, 2000). In 2005, demographics of patients from OIF found that 94% of evacuees were of routine nature (Harman, Hooper, & Gackstetter, 2005). Patient information was a focus of a 2009 study emphasizing a need for standardized scoring to determine when to evacuate international travelers (Duchateau, Verner, Cha, & Corder, 2009).

A 1976 article titled “Five-Year Study of Emergency Aeromedical Evacuation in the United States” showed how extensive the Urgent or Priority AE mission was before TRICARE (Johnson Jr., Cooper, & Ellegood, 1976). During this time the AE mission was responsible for upholding the DOD policy that the movement of armed forces patients would be accomplished by military AC. This equated to 7056 patient movements (PMs) between 1 July 1969 and 30 June 1974. The chart below summarizes some of the results found in the article (over five year period).

Table 2: Summary of 1976 Article

	Average Monthly Number of	
	C-9A Launches for Urgent Patients	Patients Moved on a Priority Basis
July	26	69
August	25	66
September	23	54
October	21	58
November	21	52
December	19	53
January	17	63
February	17	55
March	22	68
April	19	50
May	25	69
June	19	58
TOTAL	254	715

The article also noted 1032 diversions of C-9A's from their pre-planned "routine patient" missions to pick up Urgent patients (over the five years). Other aspects of the article focused on where the patients were coming from in which the numbers suggested that the C-9A, which was housed at Scott AFB should rather be located in the South West or South East area (where 52 % of the Urgent patients were airlifted from). An edited map from the article is presented below to define these areas.



Figure 6: Map of Regions from 1976 Article

Their suggested area for a dedicated asset contains the weighted mean center (WMC) based off of the current AF population presented later. They found that the distances between medical facilities in the Far West and North East were within acceptable automobile driving ranges to meet acute medical requirements; this was well before the Defense Base Closure and Realignment Commission which downgraded many military hospitals to clinics in 2005 (BRAC Commission, 2005). Another aspect of interest in the article was which type of patient was being moved. Pediatrics and Burns each

represented 20 % of Urgent patient movements over the 5 year period followed by Neuro Surgery at 15 % and Thoracic Surgery at 12 %.

One final excerpt from the article was the following, quoted below.

“Less than 6 h after the request for urgent help was received in the Patient Airlift Center at Scott AFB, IL, the patient was delivered to his destination hospital for definitive care.”

Less than 6 hours, even in 2013 would be invaluable in ensuring patients reached advanced military medical care. Patients seen in-house (military) benefit from providers who are familiar with military medical concerns and have easy access to Electronic Medical Records (EHRs) through the AHLTA or Armed Forces Health Longitudinal Technology Application (AHLTA, 2013).

Reviewing Air Mobility Operations Joint Publication 3-17 highlighted the current philosophy and desire for a flexible system (USAF, 2 Oct 2009). The following excerpt is from an AE success story within the publication.

“The ability to use virtually any aircraft on-site or in-system (vice the old system of dedicated AE aircraft) provided a quick response to casualty movement requirements.”

The idea of dedicated AE aircraft lends itself to the notion of decreased flexibility. This is problematic for theater operations where the unyielding performance measure (and rightly so) is patient lives. However in a more stable stateside setting, using a dedicated aircraft could potentially reduce costs without jeopardizing patient survivability. Options to reduce cost are challenged by the desire to have AF assets accomplish AE missions. Several benefits exist with such a notion, one being that by

keeping missions in house allows AE medical personnel to keep up their clinical skills. This however may not be the best financial based option with high flying hour costs associated with aircraft like the C-17. To decide what means to transport a patient the following Patient Movement Planning and Execution Algorithm from AFTTP 3-42.5 is used.

PATIENT MOVEMENT PLANNING AND EXECUTION ALGORITHM

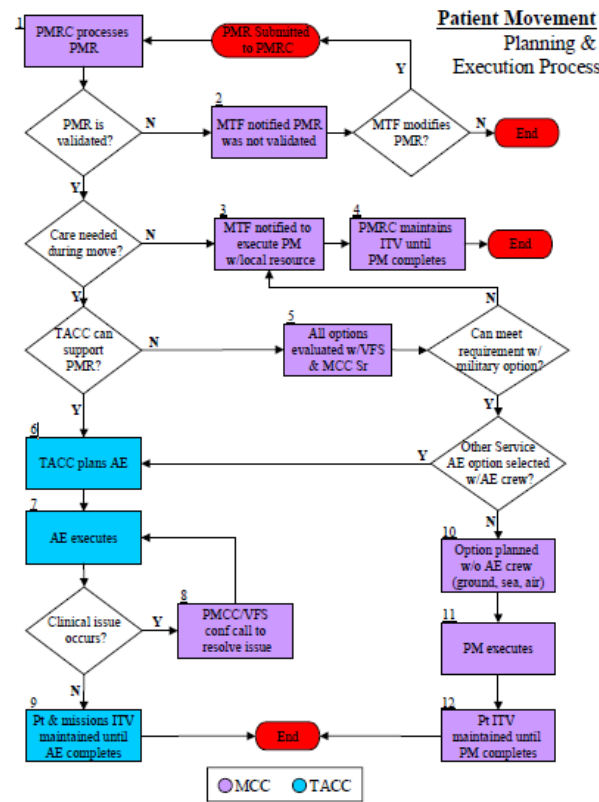

Figure 7: AFTTP 3-42.5 Flowchart

The process starts when a Patient Movement Request (PMR) is submitted to the Patient Movements Requirement Center (PMRC) by the requesting Medical Treatment Facility (MTF); PM is defined as “process of moving sick, injured, wounded, or other person to obtain medical, dental, or other treatment” (Department of Defense Instruction,

2012). Planning begins when the PMRC processes the PMR and decides if the PMR is validated. Validation refers to determining if care is needed during the move and can the Tanker/Airlift Control Center (TACC) support the PMR. If the PMR is not validated then it is sent back to the MTF for modification for resubmittal. If care is not needed in-flight then the local MTF is notified to execute the PMR with local resources; the PRMC maintains In-Transit Visibility (ITV) until the request is completed. If the TACC cannot support the PMR then all options are evaluated by the Validating Flight Surgeon (VFS) and the Senior Mission Clinical Coordinator (MCC). From this node (5) a PMR can either be performed using local resources or other service AE options (Army or Navy) with or without an AE crew. If planned without an AE crew, ITV is maintained until the PM completes. If other services are selected with an AE crew then the TACC plans and executes the AE; this is the same if the TACC originally supports the PMR. If clinical issues arise during the move the Patient Movement Clinical Coordinator (PMCC) and VFS have a conference call to resolve the issue. If not ITV is maintained through to completion.

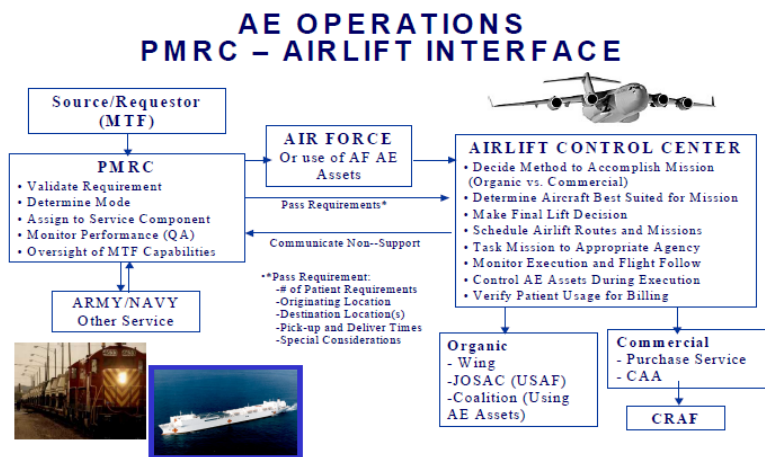

Figure 8: AFTTP 3-42.5 Visual Diagram

The above figure also located in AFTTP 3-42.5 provides an overview of the process. The figure highlights how AE is not a rigid system but instead one that is flexible to patient demands and the availability of different types of transport. One aspect that lacks any presence in these two figures is cost.

An article in the Air Force Times highlighted one situation where potential savings exist (Ricks, 2011). The story was of a C-17 loaded with 3 critically injured patients making the “eight-hour flight across the Atlantic”. If an AC with flying hour costs closer to the C-37B (aka G550) was used (assuming equivalent levels of care), the savings would have been \$ 74,768; using flying hour costs from AMC spreadsheet (AMC , 2012).

Equation 1: Cost Difference

$$8 * (C17 \text{ Flying Hour Cost} - C37B \text{ Flying Hour Cost}) = 74,768$$

The C-17 carries an \$ 11,415 flying hour cost as compared to the C-37B’s cost of \$ 2,069. This simple look at flying hour costs highlights the potential benefit of having an asset tailored to the Urgent and Priority mission. Despite the savings, a large fleet of C-37B’s could not avert situations where non-specialized AC would be used to accomplish movements due to the random nature of Urgent and Priority patient requests (unless every airman had their own AC!).

A figure (below) from the 9 September 1998 DODI 6000.11 summarizes the cost decision process of AE (Department of Defense Instruction, 1998).

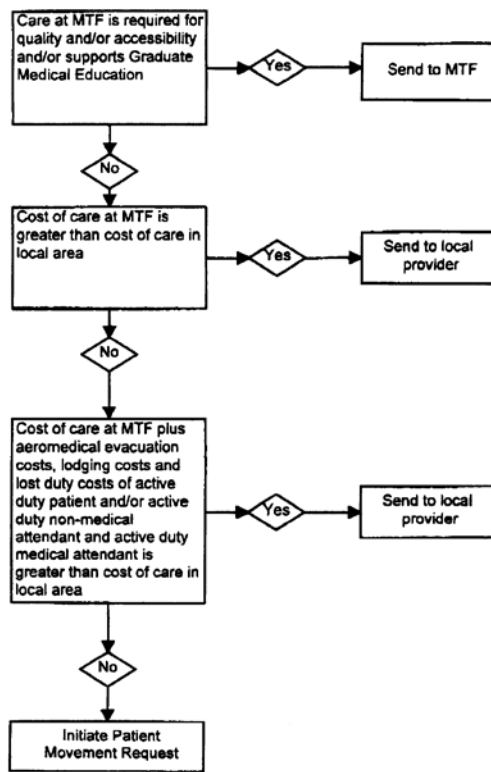

Figure 9: DODI 6000.11 Decision Flowchart

Before TRICARE the two steps to send patients to local providers would not be an option. One aspect of the final decision process to be noted is that the flying hour costs will be 0 \$ if scheduled using available readiness baseline flying hours since they are already funded. This idea would be interesting if applicable to a dedicated or designated AC that would service as the Urgent/Priority AC of the continental US. This could be optimized to ensure maximum use of training flying hours for AE.

Further investigation involving HQ AMC produced the “Aeromedical Evacuation / En Route Care Capabilities-Based Assessment Report” (USAF, 31 July 2012). Upon review of the report it was clear that current economic climate was calling for efficient

improvements to AE. Systemic Gap number 22 “AF needs to determine how to utilize/optimize all airlift assets in support of PM requirements” identified that AMC is driven to optimize AE by increasing flexibility. The assessment also called for determining the feasibility of dedicated contracting (AE) support which further backed up the notion of having a “dedicated” asset for the process (albeit support in this case refers to personnel). Having a contract like the one proposed to AFRICOM would include all costs from maintenance, crew and fuel wrapped up in the total cost. The one downside to such a contract would be that it takes away the training platform for AE crews to maintain their clinical currency.

Past AFIT Research

An AFIT thesis from 1995 was aimed at giving the Global Patient Movement Requirements Center (GPMRC) a tool to efficiently forecast AE assets in the “lift-bed” process; “lift-bed” refers to ensuring that an airlifted patient will have a hospital bed available to them at the end of their mission (Kimminau, 1995). The tool was a mixed integer linear program (MILP) model built in FORTRAN giving solutions for the number of dedicated C-141s needed to complete the AE mission (Fortran). Getting patients to where they belong had been an issue during the Persian Gulf War which led to the creation of the decision support system, TRAC2ES (TRANSCOM regulating and command and control evacuation system) (Kott, Saks, & Mercer, 1999). Currently still in use, TRAC2ES tracks patients from initial care until they reach their destination hospital reacting along the way to airport closures and changes to hospital bed availability.

The thesis titled “An Analytical Tool to Assess Aeromedical Evacuation Systems for the Department of Defense” was aimed at giving insight into whether the AF should keep the McDonnell-Douglas C-9A Nightingale or find a replacement (Wilhelm, March 1998). The value function used in the work was as follows.

Equation 2: Wilhelm’s Value Function

$$Go * \sum w_i V(x_i)$$

Here w_i is the weight assigned to the evaluation measure i , $V(x_i)$ is the value assessed from the evaluation measure and “Go” is either 0 or 1 if the alternative passes all NO-GO/GO criteria. Some of the evaluation measures range from Speed, Capacity to Temperature Control (all 31 are summarized in a table below).

Table 3: Evaluation Measures

<i>Aircraft Performance</i>	<i>Mission Performance</i>
Reliability	Capacity, Litter
Speed	Capacity, Ambulatory
Range	Capacity, Medical Crew Seats
2 nd Role	Integral Litter Ramp
Aerial Refuel Capability	Ability to Reconfigure
Survivability	Temperature Control
Logistics Tail	Isolation Area
Comm/Nav Capability	Central Monitoring
Runway Required, Hard Surface	Galley
Runway Required, Unprepared Strip	Comfort Pallet

Self-Start	Noise and Vibration
Ground Refuel Without Stands	Medical Work Space and Equipment Storage
Unassisted Maneuverability	Electricity, Configuration
	Vacuum System, Configuration and Built-In O ₂ ,
	Oxygen Outlets
	Electricity, Back and Vacuum System, Back-Up
	Built-In O ₂ , Liquid Quantity
	Lighting, Illumination
	Lighting, Blackout

The scores generated placed the C-9A (both modified and baseline) at the bottom of a list of aircraft including the C-17. This was not surprising since at the time the C-9A was a dated aircraft in need of modification to meet FAA requirements. The C-17 faltered when operating costs were factored into the analysis. Below is an excerpt from the study.

“Of the larger aircraft, the C-17 in particular provided overall high value that was significantly curtailed by its surprisingly low litter capacity. When LCC (Life Cycle Costs) were considered, however, the extreme expense of the system forced it to the bottom of the alternatives list.”

The flexibility of the C-17 makes it an ideal “theater” asset however within the continental US it is over-qualified for Urgent and Priority AE missions. Such missions occur randomly within the continental US and being that the C-17 is one of the

workhorses of the fleet its availability is better than cheaper options like the C-130 and KC-135.

A thesis by W. Tod Whetstone, USAF “A Heuristic Approach for Aeromedical Evacuation System Scheduling and Routing” developed the idea of optimizing the use of dedicated aircraft (Whetstone, December 1988). The work first looked at a weekly scheduling problem utilizing a patient demand matrix that split the continental U.S. into 6 regions.

$$P_{ijk} = \text{Patient demand from region } i \text{ to region } j \text{ on day } k$$

The matrix was “based primarily on the historical frequency of patient demands” and led to the use of a heuristic algorithm to solve the problem. Several constraints like capacity and number of vehicles available were used to find an optimal schedule.

The second discipline of the thesis by Whetstone took aim at the daily routing problem of the aircraft. The main objective was to minimize the total distance traveled subjected to constraints.

Equation 3: Whetstone’s Objective Function

$$z = \sum_{i=1}^I \sum_{j=1}^J \sum_{k=1}^K d_{ijk} x_{ijk} \quad \text{for } i \neq j$$

The above is the objective function of the model where d_{ijk} is the distance from node i to node j on leg k of the route. By finding the arcs traveled in the model the ($x_{ijk} =$ 1) total distance can be minimized.

A thesis that expanded on Whetstone’s work was “A Dynamic Programming Approach to The Daily Routing of Aeromedical Evacuation System Missions” by David C. Mullen, USAF (Mullen, June 1989). The routing problem was modified to

incorporate time constraints; time window constraints, origin/destination precedence requirements and flow/time relationships. This problem was motivated by the fact that AE schedulers were manually selecting stops to meet mission requirements like the 16 hour crew-duty-day restriction. A dynamic programming algorithm was developed and its performance was compared to actual scheduled AE missions (using the same information).

Going further back to a 1993 thesis by Micheal J. Loftus, USAF aimed at giving AMC insight into how they assign patients that need aeromedical attention (Loftus, 1993). The objective of the study was to minimize the total patient wait time. This was done by assigning patients to AE AC and routing them to a single airport using a heuristic algorithm. Routing was a key factor of a fleet of C-9A's that were dedicated to the AE mission.

Another work from AFIT on AE was an article “The Use of Simulation to Evaluate Strategic Aeromedical Evacuation Policy and Planning” by Charles W. Wolfe, Jr., USAF focused on the Civil Reserve Air Fleet (CRAF) (Charles W. Wolfe, 1993). The work utilized simulation and multivariate analysis to analyze measures like how long a patient spends in the AE system. The work found that “resource located at the departure point to CONUS missions”, “regulation policy used” and “number of AC available” significantly affected strategic AE operations.

Research Questions

What if the AF had a dedicated, specialized AC (either owned or contracted) that could be tasked first before looking into the current fleet of non-specialized AC? In

Australia, fixed-wing aeromedical services need to be able to cover vast distances to reach different pockets of indigenous communities (Margolis & Ypinazar, 2009). Their aircraft can carry 2 patients on stretchers which is similar to the capacity of the C-37B (aka G550). The similarities between isolated Indigenous populations in Australia is very similar to scattered military personnel within the US.

Secondly, what if the intention of a dedicated asset was not to cover the entire Urgent and Priority mission but rather a significant portion as compared to the current fleet? There would be a dual purpose to such a system. This would optimize costs associated with the AC involved and also ensure that AC best suited for times of conflict (C-17, C-130 and KC-135) would get training experience. These questions are some that inspired this work.

III. Methodology

The Methodology to this work is framed below.

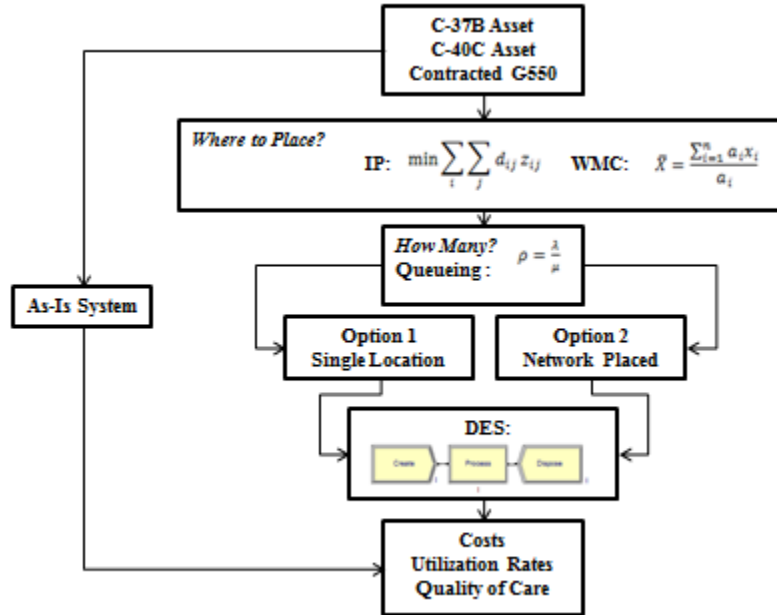

Figure 10: Methodology Chart

Four alternatives are the basis of the study. The first alternative will be the AC utilized from the current system (As-Is) of C-17, C-130 and KC-135; the flying costs of these AC will be used on the simulation output to develop comparison costs. The second and third scenario will focus on the idea of AMC having an assigned and dedicated C-37B or C-40C (redistributed from the current AF fleet) for AE patients, utilizing the current system only when busy. The final alternative will only differ (from the second and third) in how the costs are generated since utilizing a contracted asset (G550).

HQ/AMC provided several references regarding flying hour cost that were used for the comparison of the alternatives (FY2013 data). The individual Latitude and

Longitudes of the different bases in the study were attained from a website (geohack) as well as the different base Active Duty populations (Military Zone).

Location



Figure 11: CONUS AFB Locations

A CONUS map of AF installations was used to develop the idea of sections of responsibility. This assumes that the placement of AF bases is a good means to determine appropriate coverage for the notional AE Discrete-Event Simulation (DES) model. AF AE services all branches of the military so the results may not accurately reflect coverage for all military personnel. Also, this assumes that bases that do not have an active runway can utilize local airports for transferring patients. The Air Force Bases (AFBs) from the map minus the endpoints of care (EPCs) are listed in the table below

with longitude and latitude as well as population; locations within 50 miles of an EPC are not included. This 50 mile radius assumes that the military EPCs do not have their own air ambulance.

Table 4: Base Locations and Populations

Installation	Latitude (N)	Longitude (W)	Base Population	Installation	Latitude (N)	Longitude (W)	Base Population
Altus	34.67	99.27	1845	Luke	33.54	112.38	5694
Arnold	35.39	86.09	55	MacDill	27.85	82.52	6731
Barksdale	32.50	93.66	5372	Malmstrom	47.51	111.19	3363
Beale	39.14	121.44	3191	Maxwell	32.38	86.36	15000
Buckley	39.70	104.75	1445	McChord	47.15	122.48	3624
Cannon	34.38	103.32	3484	McConnell	37.62	97.27	2800
Charleston	32.90	80.90	3200	McGuire	40.02	74.52	5241
Columbus	33.64	88.44	1165	Minot	48.42	101.36	4536
Davis-Monthan	32.17	110.88	6500	Moody	30.97	83.19	3700
Dover	39.13	75.47	1746	Mountain Home	43.04	115.87	4514
Dyess	32.42	99.86	4666	Nellis	36.24	115.03	6376
Edwards	34.91	117.88	4900	Offutt	41.12	95.91	9087
Eglin	30.48	86.53	8249	Patrick	28.24	80.61	3209
Ellsworth	44.15	103.10	3033	Peterson	38.82	104.70	3805
Fairchild	47.62	117.66	3398	Pope Army Airfield	35.17	79.01	2800
Francis E. Warren	41.13	104.87	4400	Robins	32.64	83.59	6330
Goodfellow	31.43	100.38	2000	Schriever	38.80	104.53	2025
Grand Forks	47.96	97.40	3041	Scott	38.55	89.84	5162
Hanscom	42.47	71.29	2036	Seymour Johnson	35.34	77.96	4267
Hill	41.12	111.97	4481	Shaw	33.97	80.47	5690
Holloman	32.85	106.11	3955	Sheppard	33.99	98.49	10985
Hurlburt Field	30.43	86.69	7798	Tinker	35.42	97.39	8621
Keesler	30.41	88.92	6081	Tyndall	30.08	85.58	4930
Kirtland	35.04	106.61	3984	USAF Academy	38.99	104.86	2541
Langley	37.08	76.36	7957	Vance	36.34	97.92	735
Laughlin	29.36	100.78	1402	Vandenberg	34.73	120.57	3297
Little Rock	34.92	92.15	4375	Whiteman	38.73	93.55	3347
Los Angeles	33.92	118.37	1405	Wright-Patterson	39.82	84.05	6274

From this data, locations were addressed for the idea of utilizing a dedicated AC to handle Urgent and Priority PMRs. If AMC utilized a resource whose primary mission was AE, location would play an important role in factors like response times and costs. For the continental US, 4 different location arrangements were developed using disciplines like Integer Programming (IP).

The first would be having one AE AC bed-down location to service the entire US. In this scenario, requests (Urgent or Priority) would utilize AC from a single hub that would deliver patients to the EPC nearest to the pick-up location based on mileage only.

Second would be a 2 region model using Travis AFB and Andrews AFB to split the US in two. Each region would have its own AE AC hub and would deliver patients to the nearest EPC from the pick-up location.

A 3 region model would make up the third scenario splitting up the bases based on the EPCs. The difference in regards to the previous 2 scenarios would be that patients would be delivered to the EPC that their region is defined by versus the closest based off of mileage.

Finally a 4 region model would introduce a 4th possible EPC, the United States Air Force Academy (USAFA). The Colorado Springs area has the 10th Medical Group operating the USAFA hospital and Ft. Carson hosting the Evans Army Community Hospital offering advanced medical care. USAFA was also mentioned by members of AMC as a possible future EPC. In this 4 region design, patients are delivered to their assigned EPC unlike the first two scenarios based of mileage alone. Since Buckley AFB, Peterson AFB and Schriever AFB are close to the USAFA, they are removed from the 4 region model since they fall within 50 miles.

Table 5: Summary of Regions

	Whole US	2 Region	3 Region	4 Region
EPC determination	Closest	Closest	Assigned	Assigned
# of EPC's	3	3	3	4
Sectioned by	Not required	IP	IP	IP

Determining how to section the US into different regions of responsibility was accomplished by developing a simple IP (except for the Whole US model which did not require any sectioning). The objective of the IP was to minimize distances traveled from potential patient location to EPC while maintaining relatively even coverage of bases and population per each endpoint. The IP is featured below.

Inputs and sets:

- I* Set of patient bases, indexed by *i*
- J* Set of EPC, indexed by *j*
- a_i airman population for base $i \in I$
- p total airman population of bases
- d_{ij} distance from base $i \in I$ to EPC $j \in J$

Decision variables:

$$z_{ij} \begin{cases} 1, & \text{if base } i \in I \text{ assigned to EPC } j \in J \\ 0, & \text{if not} \end{cases}$$

Using this notation the problem is formulated below (Daskin, Snyder, & Berger, 2005):

Equation 4: Location IP

$$\begin{aligned} & \min \sum_i \sum_j d_{ij} z_{ij} \\ \text{s. t.} & \sum_j z_{ij} = 1 \quad i \in I \\ & \text{IF number of bases divided by EPC is an integer} \\ & \sum_i z_{ij} = \text{number of base assignments} \quad j \in J \\ \text{ELSE} & \sum_i z_{ij} \geq \text{Minimum number of base assignments} \quad j \in J \end{aligned}$$

$$\sum_i z_{ij} \leq \text{Maximum number of base assignments} \quad j \in J$$

END IF

$$\frac{\sum_i a_i z_{ij}}{p} \geq \text{Minimum percent of population coverage} \quad j \in J$$

$$\frac{\sum_i a_i z_{ij}}{p} \leq \text{Maximum percent of population coverage} \quad j \in J$$

$$z_{ij} \in \{0,1\} \quad i \in I$$

This difference between how the models were implemented is captured in the table below.

Table 6: Summary of IP constraints

		2 Regions	3 Regions	4 Regions
Number of Base Assignments	Minimum	28	18	13
	Maximum	28	19	13
Percent of Population	Minimum	0.49	0.32	0.24
	Maximum	0.51	0.34	0.26

Since the 2 and 4 regions model could be split up evenly, their respective minimum and maximum number of base assignments are equal. The intention was to relax the number of assignments per AE AC hub however solutions were feasible with these constraints in place. The percent of population constraints ensure that one AE AC hub does not have a disproportional amount of coverage based on population.

To solve these IPs, LINGO a linear program solving application was utilized (LINDO System INC., 2013). The results provided the foundation to find the different WMCs for the different regions. The code and results from LINGO are included in the appendix.

The population WMC was used to determine the best location within a region for locating dedicated assets (Sahoo). Latitude, Longitude and Population were utilized to find each WMC.

Equation 5: WMC Formulation

n = number of bases in region
 x_i = latitude reading for base i (N)
 y_i = longitude reading for base i (W)
 a_i = population for base i

$$\bar{X} = \frac{\sum_{i=1}^n a_i x_i}{\sum_{i=1}^n a_i}$$

weighted latitude coordinate

$$\bar{Y} = \frac{\sum_{i=1}^n a_i y_i}{\sum_{i=1}^n a_i}$$

weighted longitude coordinate

Once each WMC for the different regions is found, the nearest base is deemed the candidate site to locate AE AC. To find the distances needed for comparison, the haversine formula is implemented using MATLAB (MathWorks, 2013); actual code can be found in the appendix (Peyrad, 2011). The following table summarizes the candidate sites for the model.

Table 7: Nearest Locations to WMC

Whole US	Whole US			
	Tinker AFB			
2 region	Travis AFB Region	USAFA Region	Brooks AFB Region	Andrews AFB Region
	USAFA			Robins AFB
	3 region	Hill AFB	Barksdale AFB	Shaw AFB
	4 region	Nellis AFB	McConnell AFB	Keesler AFB

The haversine formula was also used to find the EPC that was closest to the potential patient locations. These distances were needed for the Whole and 2 region scenarios.

MATLAB also generated average and maximum distances for the WMC's and candidate sites of the different regions. The table below relates to the candidate sites for AE.

Table 8: Distances to Patient

	Whole US		Travis AFB Region		USAFA Region		Brooks AFB Region		Andrews AFB Region	
	Avg	Max	Avg	Max	Avg	Max	Avg	Max	Avg	Max
Whole US	744.31	1574.09								
2 region			508.64	1049.34					465.10	1041.55
3 region			497.93	834.78			426.56	793.17	399.56	1303.67
4 region			465.69	988.91	417.48	773.56	360.02	713.53	317.13	653.08

As the number of AE locations increase, the average distances decrease. This is highlighted below by taking the averages from above.

Table 9: Average Distances to Patient

	To Patient	
	Avg Dist	Max Dist
Whole US	744.31	1574.09
2 region	486.87	1045.45
3 region	441.35	977.21
4 region	390.08	782.27

Having the mileage “to the patient” is the first step followed by finding the average distances “to the EPC”. The following table summarizes the average distances and maximum distances for the different regions.

Table 10: Distances to EPC

	Whole US		Travis AFB Region		USAFA Region		Brooks AFB Region		Andrews AFB Region	
	Avg	Max	Avg	Max	Avg	Max	Avg	Max	Avg	Max
Whole US	913.18	1779.69								
2 region			619.33	1242.98					481.26	824.30
3 region			699.34	1392.06			505.54	800.43	506.33	1204.11
4 region			562.21	1367.30	478.50	809.02	533.59	832.04	408.38	823.55

The averages per each scenario are summarized in the following table.

Table 11: Average Distances to EPC

	To Endpoint of Care	
	Avg Dist	Max Dist
Whole US	550.29	1242.98
2 region	550.29	1242.98
3 region	570.40	1132.20
4 region	495.67	957.98

Since the first two scenarios take patients to the nearest EPC based solely on mileage, their respective averages are equal. The 3 and 4 region models utilize the IP's solution to send patients to the EPC. The main reason is that it would not be realistic (based on AMC information) to have a single EPC. The use of Travis AFB Area, Brook AFB Area and Andrews AFB Area were used based on AMC input for current EPCs. The United States Air Force Academy (USAFA) and Wright Patterson Air Force base (WPAFB) were also mentioned as possible EPCs for AE missions. To expand the idea of having a 4 region network, USAFA was chosen over WPAFB as the 4th EPC since WPAFB is closer to another EPC (Andrews AFB).

The total distance for the notional AE Urgent/Priority mission is summarized in the following table.

Table 12: Mission Distances

	Average Distance			
	To Patient	To Endpoint	To Hub	Total
Whole US	744.31	550.29	864.03	2158.64
2 region	486.87	550.29	745.19	1782.36
3 region	441.35	570.40	437.20	1448.95
4 region	390.08	495.67	419.66	1305.41

The total average distance represents the trip from the AE AC hub to the patient location, then delivery to EPC and finally the return trip to the hub. These numbers are

per mission hence the reduction in mileage as the US is split into more regions. To utilize this information data was needed from the AE system which is summarized below.

Table 13: AE Data Utilized

		Amount	Value Measure	Derived From
	Cruise Speed	609	mph	G550 & C-40 handouts
	Onload and Offload times	0.50	hours each	AFPAM10-1403 for C-130
	Takeoff factor	0.33	hours	estimate
	Landing factor	0.17	hours	estimate
	Minimum Crew Rest Times	16.00	hours	AFPAM10-1403 for C-130
Owned Asset	C-37B Flying Hour Cost	\$ 1,841.00	dollars	AMC handout
Contract	Annual Runway Cost	\$ 3,708,000.00	dollars	CCA handout
	per Mile up to 200K	\$ 8.15	dollars	CCA handout
	per Mile 200K-400K	\$ 7.00	dollars	CCA handout
	per Mile over 400K	\$ 5.15	dollars	CCA handout

The table above was produced from various AE sources, starting with cruise speed (Mach 0.80) which was pulled from an informational handout of the G550 AC (Gulfstream Aerospace Corporation, 2010). The Mach speed range of 0.78 to 0.82 associated with the C-40 AC was taken from a Boeing document (Bartlett & Gossett, 2011) and verified by the relevant AF fact sheet (AF.MIL, 2011). The Mach speed of 0.80 was used for the speed of both AC which when converted (used Wolfram Alpha (A Wolfram Research Company, 2013)) equates to roughly 609 miles per hour. Onload and offload times are estimated based on information from an Air Force Pamphlet (AFPAM 10-1403) regarding AE. The times of one hour and thirty minutes from the C-130 are used as a guide to estimate what the G550 times would be. Takeoff and Landing factors are to account for reduced speeds during both events; these times were loosely based off of what was found in Mullen's Thesis (Mullen, June 1989). Minimum Crew Rest Times (MCRTs) were added based again off of the C-130; this assumes only one crew is available for AE. In the absence of data, the Annual number of Urgent/Priority missions will come from the number of patient redistributions in 2011 (AMC, 2011).

The C-37B and C-40C flying hour costs come directly from an AMC handout (AMC , 2012). The initial drive for the study focused on the high costs related to the C-17 which is pulled at times for missions where a smaller AC could be utilized. The final section lists numbers related to having a G550 contract; these numbers were found in a Cost Comparison Analysis for Pacific Command (PACAF).

Using the information from the table above, response times and utilization rates were found. To get mission times, the formula below (within the box) was used.

Equation 6: Mission Times

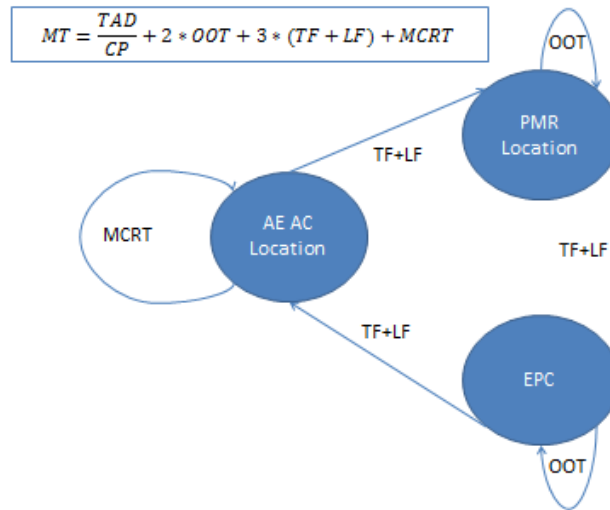

Here mission times (MT) are an average number generated from the total average distances (TAD) divided by cruise speed (CP) and adding 2 onload and offload times (OOT), 3 takeoff (TF)and landings (LF) and finally adding the minimum crew rest times (MCRT). Once these times were collected (for each of the different regions) the utilization rates could be determined using Queueing theory.

Queueing

For the Urgent/Priority AE mission, the interarrival times (λ for arrival rate) of PMRs would assume to follow an exponential distribution. The exponential has the Markov memoryless property that in this case means a cardiac patient request at Tyndall AFB has no influence on the occurrence of a trauma patient request at Holloman AFB (Gross, Shortle, Thompson, & Harris, 2008). The service times (μ) found earlier typically do not follow an exponential distribution but rather possibly an Erlang type-6. However, since the focus here is on utilization rates or traffic intensity (ρ), the formula for finding these rates are the same ($\rho = \frac{\lambda}{\mu}$ for exponentially distributed interarrival times, generally distributed service times and of one server denoted with Kendall-Lee notation M/G/1). The utilization results from Queueing Theory Software (QTS) plus, an Excel Queueing solving tool (Shortle, 2008), are as follows.

Table 14: M/M/1 Results

	Estimates in hours		Days	
	Total Mission Time	Service Rate	Arrival Rate	Utilization
Whole US	22.0446	1.0887	0.4382	0.4025
2 region	21.4267	1.1201	0.2191	0.1956
3 region	20.8792	1.1495	0.1461	0.1271
4 region	20.6435	1.1626	0.1096	0.0942

Based on current information regarding AE, a single dedicated resource would only be utilized roughly 40% of the time. Splitting the US into regions only drops utilization rates and thus increasing the amount of time these resources (AC) would be idle. To further illustrate these rates, a table was created to see the effects of increasing the amount of annual PMRs and available AC (below).

Table 15: Queueing Utilization Table

Annual Flights	Servers	Regions			
		CONUS	2	3	4
156	1	0.4025	0.2012	0.1342	0.1006
	2	0.1956	0.1001	0.0667	0.0500
	3	0.1271	0.0648	0.0432	0.0324
	4	0.0942	0.0480	0.0320	0.0240
312	1	0.8050	0.4025	0.2683	0.2012
	2	0.4004	0.2002	0.1335	0.1001
	3	0.2591	0.1296	0.0864	0.0648
	4	0.1918	0.0959	0.0639	0.0480
468	1	1.2075	0.6037	0.4025	0.3019
	2	0.6005	0.3003	0.2002	0.1501
	3	0.3887	0.1943	0.1296	0.0972
	4	0.2877	0.1439	0.0959	0.0719
624	1	1.6100	0.8050	0.5367	0.4025
	2	0.8007	0.4004	0.2669	0.2002
	3	0.5182	0.2591	0.1727	0.1296
	4	0.3836	0.1918	0.1279	0.0959

Here, servers represent AC at an AE AC hub and utilization rates are based on each AC (therefore in the 4 region model with 4 servers there would be a total of 16 AC). Utilization rates over 50 % are highlighted to showcase reasonable ranges for this value measure. Rates over 100 % would indicate a situation where the current system (C-17, C-130 and KC-135) was relied on more heavily to fill the overflow. To get an idea at how often the as-is system would be utilized in such a scenario, a simulation model was developed to glean insight.

Simulation

“Simulation is the imitation of the operation of a real-world process or system over time” and in this case the AE Urgent operation (Banks, Carson II, Nelson, & Nicol, 2010). DES Simulation “is the modeling of systems in which the state variable changes only at a discrete set of points in time”. Events that drive the AE process are PMRs that are well suited for the nature of DES. AE DES conceptualization was done using Arena

simulation software which is well equipped for handling DES problems (Rockwell Software). Translating the proposed system into a model was aided by using Arena. Arena utilizes a Graphical User Interface (GUI) allowing users to easily build models while following their progress. Verification is easier since the GUI provides an easier visual representation than lines of code. Validation can also be easier due to the visual construct of Arena; sponsors at AMC were able to give face validity to the model from the GUI. Qualification can be easier as well in Arena; it involves finding that the math agrees with the nature of what is being modeled (Cochran, 1987). These principles are important to Simulation models since it is not the intent to model reality exactly. Most real world problems under study are complex and modeling aims to find a balance between assumptions and the random nature of systems.

The experimental design (decisions to be made when running a model) for the AE DES needed to be addressed before moving forward. First, the simulation will be terminating instead of a steady-state model due to the fact that queues (for Urgent and Priority requests) are expected to be empty. Also since queues are not expected to form, the model will not utilize a warm-up period. Each replication will run for 365 days to ensure more random behavior across the replications since the model is relatively simple and non-steady-state. The model will make 30 independent replications allowing for classical statistics to be applied to the performance measures (Kelton, A Tutorial on Design and Analysis of Simulation Experiments).

From the utilization rates found in the Queueing results earlier, the first modeling decision is to only have one dedicated asset. The second decision will be to remove the

MCRT and instead assume that alternate pilots and AE personnel will be available in the event that rest times are comprised. This will decrease the utilization even further however the next decision will be to add the “redistribution” of patients to the dedicated assets AE mission.

Connected to the AE mission is the redistribution of patients once their advanced treatment ends. An example would be a severely injured patient moved from Bagram to the burn center in the San Antonio area. The AE mission encompasses this movement, ending in San Antonio. After treatment has been completed at the burn and rehab center, the patient then needs transportation back to their home station. This is just one of many examples that are known as the redistribution of patients.

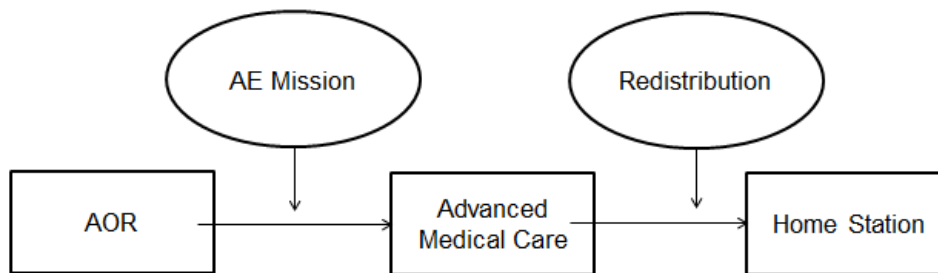

Figure 12: Redistribution Visual Aid

This movement alone cost AMC roughly 28.5 million dollars in 2011. Efforts are made to optimize these movements however subject matter experts at AMC indicate that these missions are typically carrying only one patient. Airframes such as the KC-135 and C-17 carry a heavy price tag for a movement that could be accomplished with a smaller AC. The costs from the 2011 AMC spreadsheet are summarized below (AMC, 2011).

Table 16: AMC Redistribution Costs 2011

Theater	Mission	AC Type	Flying Hour Cost	Fly Time Hours	Times Per Year	Total Fly Time	Cost
CONUS	Redistribution(cross country)	KC-135	\$ 6,993.00	15	52	780	\$ 5,454,540.00
CONUS	Redistribution(cross country)	C-17	\$ 12,336.00	18	108	1872	\$ 23,092,992.00
Totals				33	160	2652	\$ 28,547,532.00

Comparing this to the C-37B FY 2013 flying hour cost of \$ 2,069 would result in a cost difference of close to 23 million dollars less than current operations.

Table 17: C-37B Example Costs

AC Type	Flying Hour Cost	Total Fly Time	Cost	Cost Difference
C-37B	\$ 2,069.00	2652	\$ 5,486,988.00	\$ (23,060,544.00)

This is a rough estimate, however if these large and expensive AC are being used for single patient movements then room exists to optimize cost. To model this scenario, the average distance from the patient's care location to their home base and back to Tinker AFB (WMC-based location of dedicated asset) is the same as the total mileage found earlier for AE missions (in a different order).

Table 18: Redistribution Mileage

Average "Redistribution" Distance			
To Patient Care Location	To Patients Home Base	To Tinker AFB	Total
864.03	550.29	744.31	2158.64

Being that the total average distance is the same as PMRs, redistribution requests will be assumed to have the same service times. Redistribution requests per year will be centered on the amount found in 2011 of 156.

Notional Simulation Model

What if AMC had one strategically positioned AC for the Urgent / Priority AE mission and the redistribution needs they encounter? This idea stems from the initial

impression of the Queuing model that a single asset would have a low utilization. The proposed simulation model will incorporate create nodes within Arena that will generate Urgent / Priority requests, “redistribution” requests as well as requests for non-routine “milestone” maintenance (that which occurs with mileage and hours on different types of hardware). The “redistribution” requests (in hours) will be processed by the same node as the Urgent / Priority missions since both are similar in nature. Time for refueling and maintenance (between flights) occurs once the AC arrives back at Tinker AFB using a triangular distribution (1 hour minimum, 1.5 hour average and 2 hour maximum). A picture of the model is featured below.

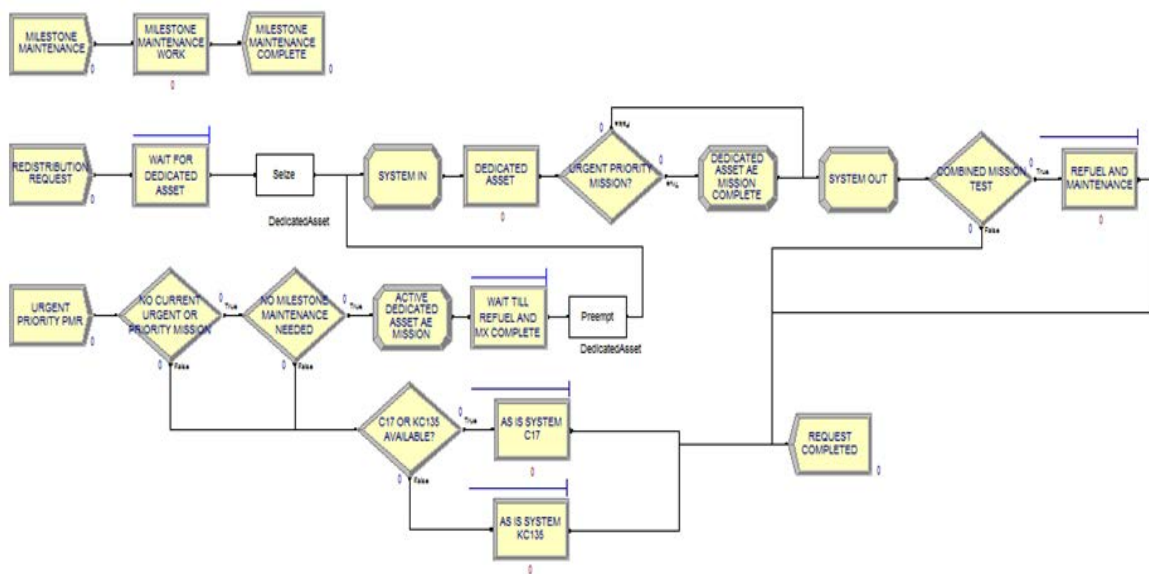

Figure 13: Simulation Model

A PMR will preempt a redistribution request that is currently in process. The time remaining for the redistribution request will be stored internally until the completion of the PMR, at which point will resume service. This in effect translates to a redistribution patient riding along with the PMR patient. Although the redistribution patient would be

traveling back to the EPC, the service time does not reset; this could be modeled with more detail however on average, the redistribution request would be preempted near to the EPC. The two situations within the model where PMRs are not processed by the dedicated asset are when the AC is with another Urgent / Priority request or is busy with milestone maintenance. When unavailable, PMRs are picked up by either a C-17 or KC-135 randomly (with the C-17 being selected two-thirds of the time and the remaining by the KC-135; this is based off the 2011 AMC report). Urgent and Priority requests will wait for the refueling and maintenance needs that are required between missions. Redistribution requests will only be serviced by the dedicated asset in the model. If the AC is busy with either redistribution request or PMR, a new redistribution request will wait until the asset returns and accomplishes refueling and maintenance. The table below summarizes the model.

Table 19: Components of Simulation Model

Entities	Process	Type of Process	Resource
Patient Movement Requests (PMR)	Dedicated Asset	Delay Release	Dedicated Asset
	C-17	Seize Delay Release	C-17
	KC-135	Seize Delay Release	KC-135
	Refuel and Maintenance	Seize Delay Release	Dedicated Asset
	Wait Till Refuel and MX Complete		
Redistribution Requests	Dedicated Asset	Delay Release	Dedicated Asset
	Refuel and Maintenance	Seize Delay Release	Dedicated Asset
	Wait for Dedicated Asset		
Milestone Maintenance Requests	Milestone Maintenance Work	Delay	

The benefit of using a simulation model (over Queuing) in this scenario is that it will capture those instances where the dedicated resource is unavailable and the current as-is system AC would be utilized. The different arrival rates (λ) within the model will follow the exponential distributions. The service rates (μ) however would need some attention since the exponential distribution would not be appropriate since service times of 0 or over 48 hours would be unrealistic for this example. Arena's Input Analyzer was used to determine a distribution adequate for the service times. The following service times (without MCRT) were fed into Input Analyzer.

Table 20: Service Times

Installation	Service Time	Installation	Service Time
Altus	4.0000	Luke	7.190
Arnold	6.3558	MacDill	7.416
Barksdale	4.2646	Malmstrom	7.919
Beale	7.0582	Maxwell	6.624
Buckley	5.3322	McChord	8.257
Cannon	4.5015	McConnell	4.393
Charleston	6.7302	McGuire	6.750
Columbus	5.1379	Minot	8.298
Davis-Monthan	7.3027	Moody	6.896
Dover	6.5390	Mountain Home	7.332
Dyess	3.9836	Nellis	7.032
Edwards	7.1734	Offutt	5.213
Eglin	5.5476	Patrick	7.450
Ellsworth	6.0361	Peterson	5.187
Fairchild	8.0610	Pope Army Airfield	6.548
Francis E. Warren	5.5891	Robins	6.660
Goodfellow	4.0341	Schriever	5.163
Grand Forks	7.7921	Scott	6.311
Hanscom	7.4530	Seymour Johnson	6.592
Hill	7.1212	Shaw	6.616
Holloman	4.9096	Sheppard	3.915
Hurlburt Field	5.5223	Tinker	3.893
Keesler	5.1249	Tyndall	5.744
Kirtland	5.0679	USAF Academy	5.232
Langley	6.5223	Vance	4.107
Laughlin	4.1879	Vandenberg	7.313
Little Rock	4.5601	Whiteman	4.868
Los Angeles	7.2975	Wright-Patterson	6.330

These times represent the total time for a dedicated asset to complete an AE mission including the time to return to the Tinker AFB hub. The average time for the patient to reach their EPC is 4.626 hours. The suggested distribution for the data was a Beta Distribution, which is known for its flexibility and use for bounded random variables (Banks, Carson II, Nelson, & Nicol, 2010). Input Analyzer suggests distributions by finding the theoretical distribution with the smallest mean square error (table below).

Table 21: MSE

Function	Sq Error
Beta	0.0231
Triangular	0.0281
Uniform	0.0313
Normal	0.0340
Weibull	0.0398
Erlang	0.0484
Gamma	0.0487
Lognormal	0.0629
Exponential	0.0725

The mean square error (MSE) is the average of the square error terms for each histogram cell between the observations and the theoretical distribution (Kelton, Sadowski, & Swets, Simulation with Arena: Fifth Edition, 2010). To ensure there wasn't a large gap in performance between the different distributions, the simulation was run with the top three distributions above (Beta, Triangular and Uniform). The model was run using 30 replications, each 365 days long and having interarrival times for PMRs of 1 day.

A summary of the key value measures of the dedicated asset are below.

Table 22: Distribution Comparison

	Dedicated Asset	
	Percent Tasked Utilization	
Beta	0.789	0.379
Triangular	0.781	0.389
Uniform	0.790	0.383

All these distributions are bounded and therefore have similar results. Bounded is preferred since the “resource” in all the alternatives is assumed to be ready when available. Also, the patient is assumed to be ready when the resource lands. Combining this with the fact that flight times typically have low variance makes service times relatively constant. The main difference between the value measures is that the dedicated asset resource tasking (average amount of PMRs that are accomplished by the Dedicated Asset versus the C-17 and KC-135) had subtle increases in half-widths from Beta across to Uniform. While the performance within the model was similar, the Beta was selected over the Triangular and Uniform since it tested better in Input Analyzer. The results from Input Analyzer are presented below.

```
Distribution Summary
Distribution: Beta
Expression: 3.45 + 5.29 * BETA(1.57, 1.63)
Square Error: 0.023104

Chi Square Test
Number of intervals = 5
Degrees of freedom = 2
Test Statistic = 5.75
Corresponding p-value = 0.0587

Kolmogorov-Smirnov Test
Test Statistic = 0.114
Corresponding p-value > 0.15

Data Summary
Number of Data Points = 56
Min Data Value = 3.89
Max Data Value = 8.3
Sample Mean = 6.04
Sample Std Dev = 1.29

Histogram Summary
Histogram Range = 3.45 to 8.74
Number of Intervals = 7
```

Figure 14: Input Analyzer Results

The Kolmogorov-Smirnov (KS) test above shows the corresponding p-value was greater than 0.15 meaning there isn't enough evidence to reject the null hypothesis that the observed and theoretical distribution are different.

With the inputs in place the simulation could be run to get the desired outputs highlighted in the following figure.

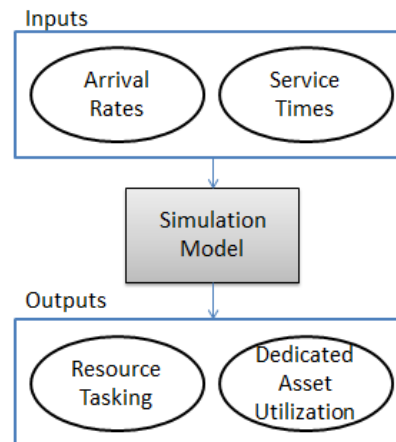

Figure 15: Simulation Overview

The purpose of the simulation was to retrieve outputs that would allow cost comparisons to be attained as well as insights regarding utilization. Resource tasking in this study is focused on how many of the Urgent and Priority PMRs are accomplished with the dedicated asset versus the overflow AC (C-17 and KC-135). With the numbers regarding resource tasking and flying hour costs, total costs can be derived of the different systems (Dedicated or Contracted). The utilization of the dedicated asset would help AMC determine if having such an AC would be plausible. Having a resource with a low utilization may or may not be advisable; low utilization may be viewed as increased readiness or alternatively inefficient use of an AC. To best extract the information desired, a Design of Experiment (DOE) was developed.

Design of Experiment

To best understand the costs associated with a system that only utilized one dedicated asset, a DOE was implemented. The two factors that would be varied are the redistribution requests and PMRs; a 3 level by 2 factor (3^2) factorial experiment yielding 9 scenarios. The 2 factors involved are the arrival rates of the entities Redistribution and PMR. A summary table of the different levels of interarrival times along with the corresponding numbers per year is presented below.

Table 23: DOE inputs

		Average Requests					
		Days Between			Number Per Year		
		Low	Mid	High	Low	Mid	High
Redistribution		4.5641	2.2821	1.1410	78	156	312
PMR		2.3576	1.1788	0.5894	151	302	604

The number of redistribution requests is based on an AMC report, centered on 156 as the mid-level; low (78) is half the mid-level and high (312) is double the amount. The days between arrivals are simply 356 divided by “Number per Year”. For the PMR row, the average number per year of 1411.2 from the 1976 journal article was utilized (Johnson Jr., Cooper, & Ellegood, 1976) along with the 78.57 % decrease caused by TRICARE in the late 90’s (70,000 mission in 1995 dropped to 15,000 in 2000 (Diamond, 2003)) to come up with the number of 302 Urgent / Priority AE Missions per year. The low (151) and high (604) numbers again represent half and double the value respectively. Although this is only a crude estimate it provides a basis to gain insight on the notional system.

IV. Analysis and Results

The results of the DOE are as follows.

Table 24: DOE results

Scenario (Redistribution/ PMR)	Percent of Missions Completed by Dedicated Asset				Dedicated Asset Utilization			
	Average	Min	Max	Half-width	Average	Min	Max	Half-width
L/L	0.903	0.874	0.939	0.006343	0.189	0.169	0.210	0.003647
L/M	0.810	0.773	0.857	0.007888	0.286	0.258	0.316	0.005496
L/H	0.689	0.660	0.728	0.005577	0.437	0.409	0.460	0.004835
M/L	0.883	0.812	0.930	0.009784	0.254	0.232	0.273	0.004377
M/M	0.811	0.771	0.850	0.006945	0.351	0.316	0.372	0.005585
M/H	0.695	0.660	0.734	0.006447	0.498	0.465	0.522	0.005860
H/L	0.903	0.873	0.939	0.006240	0.392	0.358	0.432	0.007762
H/M	0.812	0.777	0.855	0.008237	0.486	0.466	0.517	0.004699
H/H	0.692	0.668	0.724	0.005475	0.623	0.588	0.657	0.006888

Here each scenario represents 30 replications of the simulation model with the controls set at the levels from Table 23: DOE inputs. The responses show that when the days between arrivals is the lowest (4.5641 for Redistribution and 2.3576 for PMR), the dedicated asset captures 90.3 % of the Urgent / Priority AE missions and has a utilization rate of 18.9%. When at their highest, the dedicated asset still captures 69.2 % of the specified AE missions and has a utilization rate of 62.3 %. The half-widths of the different estimates show that they are relatively precise. The model is most sensitive to alteration of PMRs since they have a higher volume and also redistribution requests have a lower priority (their more of an additional “flexible” work-flow to better utilize the asset). Regression analysis was done on these results in JMP (SAS Institute Inc., 2013) to see what effects the different levels of redistributions and PMRs had on the responses (below).

Table 25: JMP results

Utilization					
Analysis of Variance					
<u>Source</u>	<u>DF</u>	<u>Sum of Squares</u>	<u>Mean Square</u>	<u>F Ratio</u>	<u>Prob > F</u>
Model	2	0.1317	0.0659	23.4306	0.0015
Error	6	0.0169	0.0028		
C. Total	8	0.1486			
Parameter Estimates					
<u>Term</u>	<u>Estimate</u>	<u>Std Error</u>	<u>t Ratio</u>	<u>Prob> t </u>	
Intercept	0.7088	0.0500	14.1800	<.0001	
Redistribution	-0.0531	0.0124	-4.2800	0.0052	
PMR	-0.1285	0.0240	-5.3400	0.0018	
Percent Accomplished by DA					
Analysis of Variance					
<u>Source</u>	<u>DF</u>	<u>Sum of Squares</u>	<u>Mean Square</u>	<u>F Ratio</u>	<u>Prob > F</u>
Model	2	0.058	0.029	33.065	0.001
Error	6	0.005	0.001		
C. Total	8	0.063			
Parameter Estimates					
<u>Term</u>	<u>Estimate</u>	<u>Std Error</u>	<u>t Ratio</u>	<u>Prob> t </u>	
Intercept	0.6497	0.0280	23.2300	<.0001	
Redistribution	-0.0001	0.0069	-0.0200	0.9839	
PMR	0.1094	0.0135	8.1300	0.0002	

The results from JMP for utilization indicate that both the levels of redistributions and PMRs are significant to the regression. For the percent accomplished by the dedicated asset (DA), PMRs are significant however redistributions have relatively no impact on the percentage. This is not surprising since they are preempted when an Urgent/Priority request is generated.

The following figure summarizes the two performance measures.

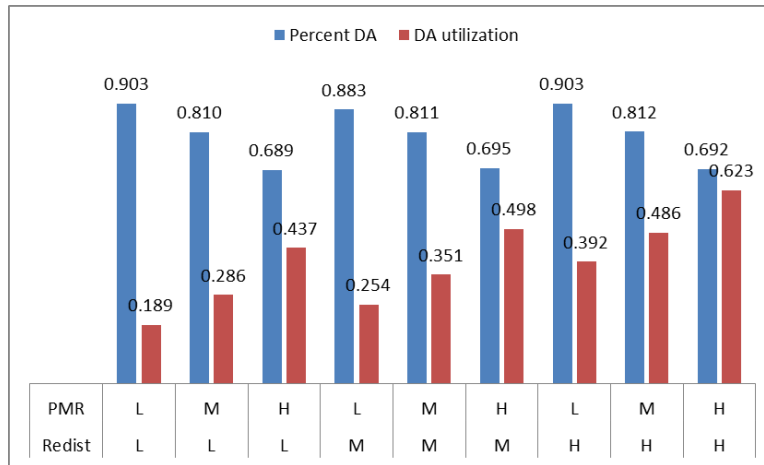

Figure 16: DOE Utilization Results

When both PMRs and redistribution requests are low, the utilization rate of the AC is only 19 %. This equates to the dedicated asset being idle 80 % of the year. This can be viewed two ways; for one, it is available for other transportation movements (Distinguished Visitor travel for example) or oppositely that the low utilization represents increased readiness/availability.

When both requests are high, the utilization rate of the dedicated asset is close to ideal at 62.3 %. This also can have two interpretations. For one, it possibly indicates a need for analysis to determine the feasibility of a second dedicated asset (since the fleet of C-17s, KC-135s are taking up roughly 31 % of missions that could be covered by a more cost-effective airframe). Alternatively, it could be viewed as providing enough use of the current system to satisfy training requirements. When forces draw down so too does the “forward” AE system that has been honing the skills of AE personnel.

The table below includes the information that will be used when generating the costing information for the different scenarios.

Table 26: Data for Developing Costs

	Miles	Reference			
Average Trip Distance	2158.64	WMC results			
				Cruise Speed (MPH)	Reference
Aircraft	C-37B (G550)	\$ 2,069.00	AMC handout	609	G550 handout
	C-40C	\$ 2,901.00		609	AF Fact Sheet
	C-17	\$ 11,415.00		563	
	KC-135	\$ 6,851.00		530	
	C-130	\$ 5,368.00		366	
	Cost	Reference			
Contract Costs	Annual Runway Cost	\$ 3,708,000.00	CCA handout		
	per Mile up to 200K	\$ 8.15			
	per Mile 200K-400K	\$ 7.00			
	per Mile over 400K	\$ 5.15			

With the above table the numbers that pertain to which AC complete the Urgent and Priority missions can be used to determine flying hours for the different airframes (below)

Table 27: DOE Flying Hours

Scenario (Redistribution/PMR)	Notional Model Flying Hours			
	DA	C-17	KC-135	Redistribution
L/L	484.07	45.48	23.62	281.68
L/M	880.35	137.01	77.25	280.61
L/H	1492.73	475.69	265.69	282.62
M/L	472.73	41.03	22.67	558.27
M/M	881.89	142.37	82.55	561.58
M/H	1483.05	483.23	261.35	554.84
H/L	473.91	42.18	20.50	1115.47
H/M	865.47	144.81	76.57	1103.07
H/H	1489.90	465.34	257.95	1115.12

With flying hours, cost estimates can be drawn for the different alternatives.

Table 28: DOE PMR Costs

Scenario (Redistribution/PMR)	PMR Costs				
	C-37B	C-40C	Contract	C-17	KC-135
L/L	\$ 1,001,542.05	\$ 1,404,288.78	\$ 6,001,592.92	\$ 519,178.60	\$ 161,840.16
L/M	\$ 1,821,450.23	\$ 2,553,903.88	\$ 7,690,944.59	\$ 1,563,929.68	\$ 529,245.24
L/H	\$ 3,088,465.06	\$ 4,330,419.11	\$ 9,359,733.88	\$ 5,430,052.42	\$ 1,820,227.49
M/L	\$ 978,074.19	\$ 1,371,383.88	\$ 5,953,239.39	\$ 468,307.94	\$ 155,338.65
M/M	\$ 1,824,625.73	\$ 2,558,356.33	\$ 7,697,487.42	\$ 1,625,203.61	\$ 565,519.76
M/H	\$ 3,068,422.04	\$ 4,302,316.26	\$ 9,329,351.13	\$ 5,516,098.53	\$ 1,790,482.39
H/L	\$ 980,516.32	\$ 1,374,808.04	\$ 5,958,271.18	\$ 481,438.07	\$ 140,438.20
H/M	\$ 1,790,648.67	\$ 2,510,716.19	\$ 7,627,480.57	\$ 1,652,951.95	\$ 524,585.36
H/H	\$ 3,082,598.10	\$ 4,322,192.88	\$ 9,350,840.28	\$ 5,311,881.26	\$ 1,767,210.89

Redistribution needs to be addressed for a total cost to be derived for the different scenarios (below).

Table 29: DOE Redistribution Costs

Scenario (Redistribution/PMR)	Redistribution Alternatives		
	C-37B	C-40C	Contracted
L/L	\$ 582,787.51	\$ 817,141.89	\$ 1,398,056.26
L/M	\$ 580,587.40	\$ 814,057.05	\$ 1,392,778.38
L/H	\$ 584,738.28	\$ 819,877.11	\$ 1,402,735.97
M/L	\$ 1,155,058.49	\$ 1,619,538.27	\$ 2,609,900.60
M/M	\$ 1,161,900.84	\$ 1,629,132.11	\$ 2,623,998.68
M/H	\$ 1,147,966.80	\$ 1,609,594.82	\$ 2,595,288.77
H/L	\$ 2,307,916.87	\$ 3,235,991.70	\$ 4,468,518.64
H/M	\$ 2,282,248.90	\$ 3,200,001.96	\$ 4,429,609.16
H/H	\$ 2,307,183.50	\$ 3,234,963.42	\$ 4,467,406.94

The redistribution of patients is assumed to be viable with the civilian contracted G550. With all the previous numbers the total costs are generated for the different systems.

Table 30: DOE Total Costs

Scenario (Redistribution/PMR)	Total Costs per System			Comparative Values		
	C-37B	C-40C	Contract	Only C-130	Only KC-135	Only C-17
L/L	\$ 2.27	\$ 2.90	\$ 8.08	\$ 7.38	\$ 6.50	\$ 10.20
L/M	\$ 4.50	\$ 5.46	\$ 11.18	\$ 12.10	\$ 10.67	\$ 16.73
L/H	\$ 10.92	\$ 12.40	\$ 18.01	\$ 21.85	\$ 19.26	\$ 30.21
M/L	\$ 2.76	\$ 3.61	\$ 9.19	\$ 9.72	\$ 8.57	\$ 13.44
M/M	\$ 5.18	\$ 6.38	\$ 12.51	\$ 14.71	\$ 12.96	\$ 20.34
M/H	\$ 11.52	\$ 13.22	\$ 19.23	\$ 24.22	\$ 21.35	\$ 33.49
H/L	\$ 3.91	\$ 5.23	\$ 11.05	\$ 14.70	\$ 12.96	\$ 20.33
H/M	\$ 6.25	\$ 7.89	\$ 14.23	\$ 19.37	\$ 17.08	\$ 26.78
H/H	\$ 12.47	\$ 14.64	\$ 20.90	\$ 29.12	\$ 25.66	\$ 40.25

Here the results include the comparative values if one of the current airframes completes all PMRs and redistribution requests. Taking the most practical current AC, the KC-135 (higher flying hour cost than the C-130 is offset by its faster speed) that of the C-37B and C-40C hybrid systems. This rides on the assumption that AMC can acquire one of the AC from the AF's current inventory and station AE crews at Tinker AFB. On average (across all scenario's), the C-37B comes in at 58 % lower than the KC-135. In the most stressed scenario 9 (604 PMRs and 312 redistribution requests) the C-37B is 51% lower in cost than the KC-135; this even when using the C-17 (for overflow) 13.2 % of the time. The C-40C hybrid system comes in at 49.2 % of the KC-135 annual average cost across all scenarios.

The contracted G550 hybrid system alternative, which utilizes the C-17 and KC-135 for PMR overflows and completes all redistribution moves, competed slightly well against the KC-135 alone. On average it came in at 3.7 % lower than the cost of the KC-135 across all scenarios. Although the result is higher, the costs associated with a contracted AC include "Crew/Gas/Maintenance". If these costs were factored in for the KC-135, it would be assumed that the contracted G550 would have the advantage.

Costs suggest the pursuit of an AC more tailored to the Urgent and Priority AE mission. When comparing the different AC from a patient care perspective, the current AE arrangement is more engineered for supporting combat operations. The following table summarizes attributes pertaining to patient care.

Table 31: Patient Care Comparison

	Onboard Oxygen	Comfort Level	Easy On & Off Loading	Mass Casualty Support	Speed of Aircraft
C-130	N	L	Y	Y	L
KC-135	N	L	Y	Y	M
C-17	Y	M	Y	Y	M
*C-37B	Y	H	N	N	H
*C-40C	Y	H	Y	Y	H
Contract G550	Y	H	N	N	H

*Assuming remodeled for Dedicated AE Mission

The C-130 and KC-135 are not noted as being comfortable AC for patients. The pair also lack onboard oxygen and the C-130 is the slowest of all AC featured with a cruise speed of 366 mph. These airframes are best suited as AC of opportunity in times of conflict and during natural disaster events. This applies to the C-17 also; however, the C-17 is noted as being the most patient care friendly set-up in the current arrangement.

A G550 under contract would be specifically dedicated to the AE mission. Patient comfort would be high and only hampered by not being considered and easy on & off AC (Air Mobility Command, 2011). Another issue with the G550 is that it would not be very effective during a mass casualty event with a capacity of 12 passengers; which leaves little room when considering space for AE medical providers and litter patients. The speed of a contracted dedicated asset would not be an issue as well as the interior being specifically made for patient care. The C-37B could assume to be equivalent to the asset

under contract since if assigned to AMC it would be assumed to be remodeled for the AE mission.

The C-40C possibly presents the most interesting possibilities. The assumption is that if assigned to AMC, it also would be remodeled for patient care. With a larger remodeled C-40C, the AE mission would have a versatile asset ready for a wide variety of missions. Patient care would be high with features like onboard oxygen and climate control. The speed would be equivalent to the C-37B and the interior would potentially be able to accommodate more patients than any of the current AE AC.

V. Conclusion, Recommendation and Future Study

After looking at different arrangements of a hybrid dedicated AE system, it is the conclusion that the C-40C is best suited for the Urgent and Priority AE mission. Based on flying hour costs, it is recommended to pursue a C-40C from the AF inventory and retrofit a large cargo door like in Figure 17: US Navy's C-40A Clipper (Defense Industry Daily Staff, 2012). Having a single dedicated asset would take a large portion of work away from non-specialized expensive AC like the C-17. The overflow from the C-40C (situations when busy) would give platforms like the C-17 and C-130 AE practice for times of conflict. This would still maintain the "Train like we fight" mentality while optimizing costs.



Figure 17: US Navy's C-40A Clipper

Future Work

This study of the AE process focused on the continental Urgent / Priority piece, which is just a small part of the total AE mission. The whole AE mission encompasses US military personnel across the entire globe. The heaviest tasked section during current times is those supporting operations abroad. When patients are in-theater, there is not a TRICARE option so transport for all AE (including all routine) must be routed out of country. The workhorse for these missions is the C-17 leaving room for retroactive studies to show if investment in a dedicated platform would have been operationally feasible and optimal.

The simulation could be expanded to explore the outer-bounds of the range of newer aircraft, servicing possibly Alaska, Hawaii and other distant US military locations from a centralized stateside location. The G550 has a 6,750 nautical mile range, thus having the ability to fly non-stop from Washington D.C. to Dubai (Gulfstream, 2012). Ranges could

be set within the model where movement of a Priority patient in Northern Africa would have the option of returning to the US versus heading to Landstuhl AB.

Mass evacuation events and how they factor into the AE mission are absent from this study. Modeling such events would be helpful in determining how dedicated and non-dedicated AC would perform. Events could range from natural disaster to ones requiring patient decontamination. Such a simulation model could give valuable insights into both arrangements.

The decision to either airlift patients or have them seen by local civilian providers could be tested with the idea of dedicated assets. Like the decision flowchart in Figure 9: DODI 6000.11 Decision Flowchart, an AF AE mission is only tasked when associated costs fall lower than local civilian care. A dedicated asset that has a lower flying hour cost then would potentially capture more AE missions. A study to determine the optimal proportion of dedicated asset missions to those sent to local civilian care could be done. Included could be a value focused thinking approach for costs and non-costs of military versus civilian care.

VI. Appendix

Acronym List

AAMS	Australian Aerial Medical Services
AC	Aircraft
AE	Air Evacuation
AFB	Air Force Base
AFPAM	Air Force Pamphlet
AFTTP	Air Force Tactics, Techniques and Procedures
Air-Evac	Aeromedical Evacuation
AMC	Air Mobility Command
CAA	Civilian Air Ambulance
Case-Evac	Casualty Evacuation
CONUS	Continental United States
CP	Cruise Speed
CRAF	Civil Reserve Air Fleet
DES	Discrete Event Simulation
DOE	Design of Experiments
DOTMLPF	Doctrine, Organization, Training, Maintenance, Leadership, Personnel and Facilities
EHR	Electronic Medical Record
EPC	End Point of Care
FAA	Federal Aviation Administration
FM	Field Manual
GPMRC	Global Patient Movements Requirement Center
GUI	Graphic User Interface
IP	Integer Programming
ITV	In-Transient Visibility
JDMS	Journal of Defense Modeling and Simulation
JOSAC	Joint Operational Support Airlift Center
KS	Kolmogorov-Smirnov
LCC	Life Cycle Cost
LF	Landing Factor
MAAF	Mobility Aircraft Availability Forecasting
MAC	Military Airlift Command

MATS	Military Air Transport Service
MC	Mission Capable
MCC	Mission Control Center
MCRT	Minimum Crew Rest Time
Medevac	Medical Evacuation
MILP	Mixed Integer Linear Program
MSE	Mean Square Error
MTF	Medical Treatment Facility
NPS	Naval Post-Graduate School
OEF	Operation Enduring Freedom
OIF	Operation Iraqi Freedom
OOT	Onload and Offload Time
PACAF	Pacific Command
PM	Patient Movement
PMCC	Patient Movement Clinical Coordinator
PMR	Patient Movement Request
PMRC	Patient Movements Requirement Center
POI	Point of Injury
QTS	Queueing Theory Software
SME	Subject Matter Expert
TACC	Tanker/Airlift Control Center
TAD	Total Average Distance
TF	Takeoff Factor
TRAC2ES	TRANSCOM Regulating and Command and Control Evacuation System
UAS	Unmanned Aerial System
USAFA	United States Air Force Academy
VFS	Validating Flight Surgeon
WMC	Weighted Mean Center
WPAFB	Wright-Patterson Air Force Base

MATLAB Code (example)

```
%initialize the environment
clear all; clc; format short;

%load the data file. 57 latitudes and longitudes of Major CONUS AFB's
load Latitude.mat;
load Longitude.mat;

latN = [29.34167,38.26278,38.81083]; % Brooks, Travis, Andrews latitude
(N)
longW = [98.43518,121.9275,76.86694]; % Brooks, Travis, Andrews
longitude (W)

for j = 1 : 3
for i = 1 : size(Lat)

% Earth radius in km
R = 6371;
% Coordinates of two points.
lat1 = latN(j);
long1 = longW(j);
lat2 = Lat(i,:);
long2 = Lon(i,:);

% Converts degrees into gradians
lat1 = lat1*2*pi/360;
lat2 = lat2.*2*pi/360;
long1 = long1*2*pi/360;
long2 = long2.*2*pi/360;
dlat = lat2-lat1;
dlong = long2-long1;
a = (sin(dlat/2))^2 + cos(lat1)*cos(lat2)*(sin(dlong/2))^2;
c = 2*atan2(sqrt(a), sqrt(1-a));
d = R*c*.6214;
x(i,j) = d;

end
end

AvgDist = mean(x);
MaxDist = max(x);
fprintf('The max distance is %3.4f \n',MaxDist)
fprintf('The average distance is %3.4f \n',AvgDist)
```

(Peyrad, 2011)

LINGO Code (2 region model)

```
model:

title Hub Allocation 2 ;

sets:
    Location : Population;
    Hub: ;
    Links(Location, Hub) : X , Distances;
endsets

data:
Location, Hub, Distances, Population = @ole('AELingoInput2.XLSX',
'Location', 'Hub', 'Distances', 'Population') ;
TotalPop = 249848;

@text() = ' to Travis AFB Area ' ;
@text() = @writefor(Links(i,j) | X(i,j) #gt# 0 #AND# j #eq# 2:
    'Assign ', Location(i),
    @newline(1));

@text() = ' to Andrews AFB Area ' ;
@text() = @writefor(Links(i,j) | X(i,j) #gt# 0 #AND# j #eq# 3:
    'Assign ', Location(i),
    @newline(1));

enddata

min = @sum(Links(i,j): X(i,j) * Distances(i,j)); ! Minimizes based off
of distances from hubs ;

@for(Location(i): @sum(Hub(j): X(i,j)) = 1); ! ensures only one hub is
assigned to a location ;

@for(Hub(i): @sum(Location(j): X(j,i)) >= 27); ! Lower number of
location assignments to a hub ;

@for(Hub(i): @sum(Location(j): X(j,i)) <= 29); ! Upper number of
location assignments to a hub ;

@for(Hub(i): @sum(Location(j): X(j,i)*Population(j))/TotalPop >= .32);
! Lower percentage of location assignments to a hub ;

@for(Hub(i): @sum(Location(j): X(j,i)*Population(j))/TotalPop <= .34);
! Upper percentage of location assignments to a hub ;

@for( Links: @BIN( X));

end
```

LINGO Code (3 region model)

```
model:

title Hub Allocation;

sets:
    Location : Population;
    Hub: ;
    Links(Location, Hub) : X , Distances;
endsets

data:
Location, Hub, Distances, Population = @ole('AELingoInput3edit.XLSX',
'Location', 'Hub', 'Distances', 'Population') ;
TotalPop = 249848;

@text() = ' to Brooks AFB Area ' ;
@text() = @writefor(Links(i,j) | X(i,j) #gt# 0 #AND# j #eq# 1:
    'Assign ', Location(i),
    @newline(1));

@text() = ' to Travis AFB Area ' ;
@text() = @writefor(Links(i,j) | X(i,j) #gt# 0 #AND# j #eq# 2:
    'Assign ', Location(i),
    @newline(1));

@text() = ' to Andrews AFB Area ' ;
@text() = @writefor(Links(i,j) | X(i,j) #gt# 0 #AND# j #eq# 3:
    'Assign ', Location(i),
    @newline(1));
enddata

min = @sum(Links(i,j): X(i,j) * Distances(i,j)); ! Minimizes based off
of distances from hubs ;

@for(Location(i): @sum(Hub(j): X(i,j)) = 1); ! ensures only one hub is
assigned to a location ;

@for(Hub(i): @sum(Location(j): X(j,i)) >= 18); ! Lower number of
location assignments to a hub ;

@for(Hub(i): @sum(Location(j): X(j,i)) <= 19); ! Upper number of
location assignments to a hub ;

@for(Hub(i): @sum(Location(j): X(j,i)*Population(j))/TotalPop >= .32);
! Lower percentage of location assignments to a hub ;

@for(Hub(i): @sum(Location(j): X(j,i)*Population(j))/TotalPop <= .34);
! Upper percentage of location assignments to a hub ;

@for( Links: @BIN( X));

End
```

LINGO Code (4 region model)

```
model:

title Hub Allocation 4;

sets:
    Location : Population;
    Hub: ;
    Links(Location, Hub) : X , Distances;
endsets

data:
Location, Hub, Distances, Population = @ole('AELingoInput4.XLSX',
'Location', 'Hub', 'Distances', 'Population') ;

TotalPop = 240032;

@text() = ' to Brooks AFB Area ' ;
@text() = @writefor(Links(i,j) | X(i,j) #gt# 0 #AND# j #eq# 1:
    'Assign ', Location(i),
    @newline(1));

@text() = ' to Travis AFB Area ' ;
@text() = @writefor(Links(i,j) | X(i,j) #gt# 0 #AND# j #eq# 2:
    'Assign ', Location(i),
    @newline(1));

@text() = ' to Andrews AFB Area ' ;
@text() = @writefor(Links(i,j) | X(i,j) #gt# 0 #AND# j #eq# 3:
    'Assign ', Location(i),
    @newline(1));

@text() = ' to USAFA Area ' ;
@text() = @writefor(Links(i,j) | X(i,j) #gt# 0 #AND# j #eq# 4:
    'Assign ', Location(i),
    @newline(1));

enddata

min = @sum(Links(i,j): X(i,j) * Distances(i,j)); ! Minimizes based off
of distances from hubs ;

@for(Location(i): @sum(Hub(j): X(i,j)) = 1); ! ensures only one hub is
assigned to a location ;

@for(Hub(i): @sum(Location(j): X(j,i)) = 13); ! Lower number of
location assignments to a hub ;

@for(Hub(i): @sum(Location(j): X(j,i)*Population(j))/TotalPop >= .24);
! Lower percentage of location assignments to a hub ;

@for(Hub(i): @sum(Location(j): X(j,i)*Population(j))/TotalPop <= .26);
! Upper percentage of location assignments to a hub ;
```

```
@for( Links: @BIN( X)); !ensures and integer solution;
```

```
End
```

LINGO Output *condensed (2 region model)

```
Global optimal solution found.  
Objective value:                43390.96  
Objective bound:                43390.96  
Infeasibilities:                0.000000  
Extended solver steps:          2  
Total solver iterations:        75
```

to Travis AFB Area

```
Assign BEALE_AIR_FORCE_BASE  
Assign BUCKLEY_AIR_FORCE_BASE  
Assign CANNON_AIR_FORCE_BASE  
Assign DAVIS_MONTHAN_AIR_FORCE_BASE  
Assign DYESS_AIR_FORCE_BASE  
Assign EDWARDS_AIR_FORCE_BASE  
Assign ELLSWORTH_AIR_FORCE_BASE  
Assign FAIRCHILD_AIR_FORCE_BASE  
Assign FRANCIS_E_WARREN_AIR_FORCE_BASE  
Assign GRAND_FORKS_AIR_FORCE_BASE  
Assign HILL_AIR_FORCE_BASE  
Assign HOLLOMAN_AIR_FORCE_BASE  
Assign KIRTLAND_AIR_FORCE_BASE  
Assign LOS_ANGELES_AIR_FORCE_BASE  
Assign LUKE_AIR_FORCE_BASE  
Assign MALMSTROM_AIR_FORCE_BASE  
Assign MCCHORD_AIR_FORCE_BASE  
Assign MCCONNELL_AIR_FORCE_BASE  
Assign MINOT_AIR_FORCE_BASE  
Assign MOUNTAIN_HOME_AIR_FORCE_BASE  
Assign NELLIS_AIR_FORCE_BASE  
Assign OFFUTT_AIR_FORCE_BASE  
Assign PETERSON_AIR_FORCE_BASE  
Assign SCHRIEVER_AIR_FORCE_BASE  
Assign SHEPPARD_AIR_FORCE_BASE  
Assign TINKER_AIR_FORCE_BASE  
Assign UNITED_STATES_AIR_FORCE_ACADEMY  
Assign VANDENBERG_AIR_FORCE_BASE
```

to Andrews AFB Area

```
Assign ALTUS_AIR_FORCE_BASE  
Assign ARNOLD_AIR_FORCE_BASE  
Assign BARKSDALE_AIR_FORCE_BASE  
Assign CHARLESTON_AIR_FORCE_BASE  
Assign COLUMBUS_AIR_FORCE_BASE  
Assign DOVER_AIR_FORCE_BASE  
Assign EGLIN_AIR_FORCE_BASE  
Assign GOODFELLOW_AIR_FORCE_BASE
```

Assign HANSCOM_AIR_FORCE_BASE
 Assign HURLBURT_FIELD
 Assign KEESLER_AIR_FORCE_BASE
 Assign LANGLEY_AIR_FORCE_BASE
 Assign LAUGHLIN_AIR_FORCE_BASE
 Assign LITTLE ROCK_AIR_FORCE_BASE
 Assign MACDILL_AIR_FORCE_BASE
 Assign MAXWELL_AIR_FORCE_BASE
 Assign MCGUIRE_AIR_FORCE_BASE
 Assign MOODY_AIR_FORCE_BASE
 Assign PATRICK_AIR_FORCE_BASE
 Assign POPE_ARMY_AIRFIELD
 Assign ROBINS_AIR_FORCE_BASE
 Assign SCOTT_AIR_FORCE_BASE
 Assign SEYMOUR_JOHNSON_AIR_FORCE_BASE
 Assign SHAW_AIR_FORCE_BASE
 Assign TYNDALL_AIR_FORCE_BASE
 Assign VANCE_AIR_FORCE_BASE
 Assign WHITEMAN_AIR_FORCE_BASE
 Assign WRIGHT_PATTERSON_AIR_FORCE_BASE

Model Title: Hub Allocation 2

LINGO Output *condensed (3 region model)

Global optimal solution found.	
Objective value:	32100.87
Objective bound:	32100.87
Infeasibilities:	0.000000
Extended solver steps:	2
Total solver iterations:	867

to Brooks AFB Area

Assign ALTUS_AIR_FORCE_BASE
 Assign BARKSDALE_AIR_FORCE_BASE
 Assign BUCKLEY_AIR_FORCE_BASE
 Assign CANNON_AIR_FORCE_BASE
 Assign DYESS_AIR_FORCE_BASE
 Assign EGLIN_AIR_FORCE_BASE
 Assign GOODFELLOW_AIR_FORCE_BASE
 Assign HOLLOMAN_AIR_FORCE_BASE
 Assign HURLBURT_FIELD
 Assign KEESLER_AIR_FORCE_BASE
 Assign LAUGHLIN_AIR_FORCE_BASE
 Assign LITTLE ROCK_AIR_FORCE_BASE
 Assign MCCONNELL_AIR_FORCE_BASE
 Assign SCHRIEVER_AIR_FORCE_BASE
 Assign SHEPPARD_AIR_FORCE_BASE
 Assign TINKER_AIR_FORCE_BASE
 Assign TYNDALL_AIR_FORCE_BASE
 Assign VANCE_AIR_FORCE_BASE
 Assign WHITEMAN_AIR_FORCE_BASE

to Travis AFB Area

Assign BEALE_AIR_FORCE_BASE
 Assign DAVIS_MONTHAN_AIR_FORCE_BASE
 Assign EDWARDS_AIR_FORCE_BASE
 Assign ELLSWORTH_AIR_FORCE_BASE
 Assign FAIRCHILD_AIR_FORCE_BASE
 Assign FRANCIS_E_WARREN_AIR_FORCE_BASE
 Assign HILL_AIR_FORCE_BASE
 Assign KIRTLAND_AIR_FORCE_BASE
 Assign LOS_ANGELES_AIR_FORCE_BASE
 Assign LUKE_AIR_FORCE_BASE
 Assign MALMSTROM_AIR_FORCE_BASE
 Assign MCCHORD_AIR_FORCE_BASE
 Assign MINOT_AIR_FORCE_BASE
 Assign MOUNTAIN_HOME_AIR_FORCE_BASE
 Assign NELLIS_AIR_FORCE_BASE
 Assign OFFUTT_AIR_FORCE_BASE
 Assign PETERSON_AIR_FORCE_BASE
 Assign UNITED_STATES_AIR_FORCE_ACADEMY
 Assign VANDENBERG_AIR_FORCE_BASE
 to Andrews AFB Area
 Assign ARNOLD_AIR_FORCE_BASE
 Assign CHARLESTON_AIR_FORCE_BASE
 Assign COLUMBUS_AIR_FORCE_BASE
 Assign DOVER_AIR_FORCE_BASE
 Assign GRAND_FORKS_AIR_FORCE_BASE
 Assign HANSCOM_AIR_FORCE_BASE
 Assign LANGLEY_AIR_FORCE_BASE
 Assign MACDILL_AIR_FORCE_BASE
 Assign MAXWELL_AIR_FORCE_BASE
 Assign MCGUIRE_AIR_FORCE_BASE
 Assign MOODY_AIR_FORCE_BASE
 Assign PATRICK_AIR_FORCE_BASE
 Assign POPE_ARMY_AIRFIELD
 Assign ROBINS_AIR_FORCE_BASE
 Assign SCOTT_AIR_FORCE_BASE
 Assign SEYMOUR_JOHNSON_AIR_FORCE_BASE
 Assign SHAW_AIR_FORCE_BASE
 Assign WRIGHT_PATTERSON_AIR_FORCE_BASE

Model Title: Hub Allocation

LINGO Output *condensed (4 region model)

Global optimal solution found.	
Objective value:	25779.83
Objective bound:	25779.83
Infeasibilities:	0.000000
Extended solver steps:	0
Total solver iterations:	795

to Brooks AFB Area
 Assign ARNOLD_AIR_FORCE_BASE
 Assign BARKSDALE_AIR_FORCE_BASE

Assign COLUMBUS_AIR_FORCE_BASE
Assign DYESS_AIR_FORCE_BASE
Assign EGLIN_AIR_FORCE_BASE
Assign GOODFELLOW_AIR_FORCE_BASE
Assign HURLBURT_FIELD
Assign KEESLER_AIR_FORCE_BASE
Assign LAUGHLIN_AIR_FORCE_BASE
Assign LITTLE_ROCK_AIR_FORCE_BASE
Assign MAXWELL_AIR_FORCE_BASE
Assign TYNDALL_AIR_FORCE_BASE
Assign VANCE_AIR_FORCE_BASE
to Travis AFB Area
Assign BEALE_AIR_FORCE_BASE
Assign DAVIS_MONTHAN_AIR_FORCE_BASE
Assign EDWARDS_AIR_FORCE_BASE
Assign FAIRCHILD_AIR_FORCE_BASE
Assign HILL_AIR_FORCE_BASE
Assign LOS_ANGELES_AIR_FORCE_BASE
Assign LUKE_AIR_FORCE_BASE
Assign MALMSTROM_AIR_FORCE_BASE
Assign MCCHORD_AIR_FORCE_BASE
Assign MOUNTAIN_HOME_AIR_FORCE_BASE
Assign NELLIS_AIR_FORCE_BASE
Assign TINKER_AIR_FORCE_BASE
Assign VANDENBERG_AIR_FORCE_BASE
to Andrews AFB Area
Assign CHARLESTON_AIR_FORCE_BASE
Assign DOVER_AIR_FORCE_BASE
Assign HANSCOM_AIR_FORCE_BASE
Assign LANGLEY_AIR_FORCE_BASE
Assign MACDILL_AIR_FORCE_BASE
Assign MCGUIRE_AIR_FORCE_BASE
Assign MOODY_AIR_FORCE_BASE
Assign PATRICK_AIR_FORCE_BASE
Assign POPE_ARMY_AIRFIELD
Assign ROBINS_AIR_FORCE_BASE
Assign SEYMOUR_JOHNSON_AIR_FORCE_BASE
Assign SHAW_AIR_FORCE_BASE
Assign WRIGHT_PATTERSON_AIR_FORCE_BASE
to USAFA Area
Assign ALTUS_AIR_FORCE_BASE
Assign CANNON_AIR_FORCE_BASE
Assign ELLSWORTH_AIR_FORCE_BASE
Assign FRANCIS_E_WARREN_AIR_FORCE_BASE
Assign GRAND_FORKS_AIR_FORCE_BASE
Assign HOLLOMAN_AIR_FORCE_BASE
Assign KIRTLAND_AIR_FORCE_BASE
Assign MCCONNELL_AIR_FORCE_BASE
Assign MINOT_AIR_FORCE_BASE
Assign OFFUTT_AIR_FORCE_BASE
Assign SCOTT_AIR_FORCE_BASE
Assign SHEPPARD_AIR_FORCE_BASE
Assign WHITEMAN_AIR_FORCE_BASE

Model Title: Hub Allocation 4



URGENT AEROMEDICAL EVACUATION NETWORK CAPACITY PLANNING



Quad Chart

- RESEARCH QUESTION**
- Is it desirable for AMC to have dedicated aircraft (either owned or contracted) that could be tasked first before using current non-specialized AC?
- RESEARCH OBJECTIVES**
- Develop idea of new hybrid dedicated asset system
 - Find best locations for AE assets
 - Determine number of AE assets at different locations
 - Use Simulation to determine costs and utilization of hybrid system

2Lt Scott C Finkbeiner
 Department of Operational Sciences (ENS)
ADVISOR
 Dr. Jeffery K. Cochran
CO-ADVISOR
 Dr. John O. Miller
RESEARCH SPONSOR
 Air Mobility Command
 Scott AFB, IL

C-130, KC-135 and C-17 make up current fleet of non-dedicated flexible aircraft. Flying hour costs range from \$5,368 to \$11,415.



Aircraft like the C-37B and C-40C can better service CONUS operations. Flying hour costs range from \$2,069 to \$2,901. *Contracted G550 costs are by mileage and include crew, fuel and maintenance

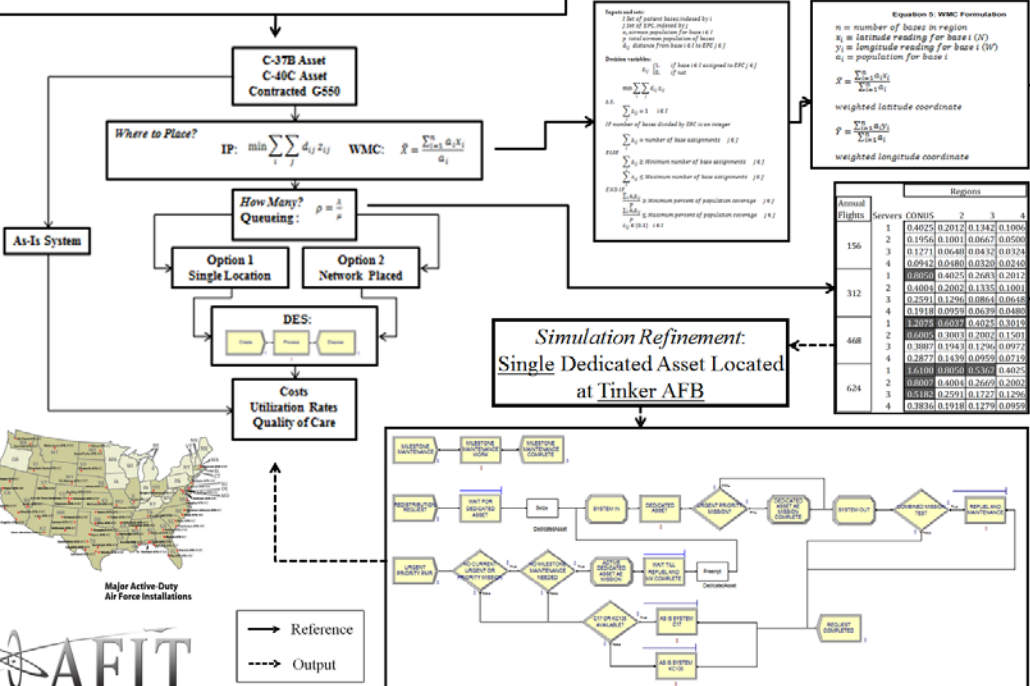

Whole US
Tinker AFB

Travis AFB Region	USAF A Region	Brooks AFB Region	Andrews AFB Region
2 region LP	USAF A		Robins AFB
3 region LP	Hill AFB	Barksdale AFB	Shaw AFB
4 region LP	Nellis AFB	McConnell AFB	Keesler AFB
			Pope AFB

RESULTS

Queueing provides good approximation for model

Queueing Comparison

Model	Mean	Std Dev	Max
Queueing	0.1887	0.1943	1.296
DES	0.1887	0.1943	1.296

Costs Utilization Rates Quality of Care

Asset	Cost	Utilization	Quality of Care
C-37B	2069	0.85	High
C-40C	2901	0.85	High
G550	5000	0.85	Low

CONCLUSION

- C-37B performs best from a cost perspective
- Contracted G550 comparable to lowest current aircraft however also includes crew, fuel and maintenance costs (requires further study)
- C-40C performs best on Quality of Care factors

RECOMMENDATION

Explore acquisition of C-40C aircraft due to low flying hour costs and potential to provide same, if not greater capacity than current aircraft.

64



Bibliography

- A Wolfram Research Company. (2013). *Wolfram Alpha*. Retrieved February 4, 2013, from Wolfram Alpha: <http://www.wolframalpha.com/>
- AF.MIL. (2011, December 12). *U.S. Air Force Fact Sheet: C-40B/C*. Retrieved January 29, 2013, from The Official Web site of the United States Air Force: <http://www.af.mil/information/factsheets/factsheet.asp?id=189>
- AFA News. (2010, October 19). *Aeromedical Evacuation*. Retrieved January 30, 2013, from Air Force Association: <http://www.afa.org/media/press/2010/HR1605.asp>
- AHLTA. (2013). *Armed Forces Health Longitudinal Technology Application*. Retrieved February 4, 2013, from AHLTA: <http://www.ahlta.us/>
- Air Force. (2003). *Aeromedical Evacuation (AE): AFTTP3-42.5*. Department of Air Force.
- Air Mobility Command. (2011). *Alternative Aeromedical Evacuation Airframe - Pacific Theater*. Scott AFB: Air Mobility Command.
- Air Mobility Command Museum. (n.d.). *C-9A/C Nightingale*. Retrieved January 30, 2013, from AMC Museum: http://amcmuseum.org/exhibits_and_planes/c-9.php
- AMC . (2012). *Flying Hour Cost Spreadsheet (FS120)*. Scott AFB: AMC.
- AMC. (2011). '*AMC Cost Breakdown*'. Scott AFB: AMC.
- Anderson, C., Konoske, P., & Davis, J. (2010). Determining How Functional Characteristics of Dedicated Casualty Evacuation Aircraft Affect Patient Movement and Outcomes. *Journal of Defense Modeling and Simulation*, 167-177.
- Army. (2009). *Medical Evacuation (FM 4-02.2, C1)*. Washington DC: Headquarters, Department of the Army.
- Army Medical. (n.d.). *Categories of Movement Precedence*. Retrieved January 14, 2013, from Integrated Publishing: <http://armymedical.tpub.com/MD0002/MD00020221.htm>
- Austin, T. K. (2002). Aeromedical Evacuation-the first 100 years. *ADF Health*, 43-46.
- Banks, J., Carson II, J. S., Nelson, B. L., & Nicol, D. M. (2010). *Discrete-Event System Simulation Fifth Edition*. Upper Saddle River: Prentice Hall.
- Bartlett, J., & Gossett, F. (2011). *Boeing: Backgrounder*. St. Louis: Boeing Global Services & Support.
- Bastian, N. D. (2010). A Robust, Multi-criteria Modeling Approach for Optimizing Aeromedical Evacuation Asset Emplacement. *Journal of Defense Modeling*, 5-23.
- Bastian, N. D., Fulton, L. V., Mitchell, R., Pollard, W., & Wilson, R. (2012). Force design analysis of the Army aeromedical evacuation company: a quantitative approach. *Journal of Defense Modeling and Simulation*, 1-8.

- Bendrick, G. A., Nicolas, D. K., Krause, B. A., & Castillo, C. Y. (1995). Inflight oxygen saturation decrements in aeromedical evacuation patients. *Aviation, Space, and Environmental Medicine*, 40-44.
- BRAC Commission. (2005). *Defense Base Closure and Realignment Commission Report*. Retrieved Mar 3, 2013, from Defense Base Closure and Realignment Commission : <http://www.brac.gov/>
- Bruce R. Guerdan, M. M. (2011). United States Air Force Aeromedical Evacuation - Critical Disaster Response Resource. *American Journal of Clinical Medicine*, 153-156.
- Charles W. Wolfe, J. (1993). The Use of Simulation to Evaluate Strategic Aeromedical Evacuation Policy and Planning. *Winter Simulation Conference*, 1089-1097.
- Christopher, G. W., & Eitzen Jr., E. M. (1999). Air Evacuation under High-Level Biosafety Containment: the Aeromedical Isolation Team. *Emerging Infectious Diseases*, 241-246.
- Ciarallo, F. W. (2005). Building the Mobility Aircraft Availability Forecasting (MAAF) Simulation Model and Decision Support System. *The Society for Modeling and Simulation International*, 57-69.
- Clingman, F. M. (1989). *Analysis of Aeromedical Evacuation in the Korean War and Vietnam War*. Air Force Institute of Technology. Wright-Patterson AFB: Air Force.
- Cochran, J. K. (1987). Techniques for ascertaining the validity of large-scale production simulation models. *International Journal of Production Research*, 233-244.
- Connor, S. B., & Lyons, T. J. (1995). U.S. Air Force aeromedical evacuation of obstetric patients in Europe. *Aviation, Space, and Environmental Medicine*, 1090-3.
- Daskin, M. S., Snyder, L. V., & Berger, R. T. (2005). Facility Location in Supply Chain. In A. Langevin, & D. Riopel, *Logistics Systems: Design and Optimization* (pp. 15-42). New York City: Springer Science+Business Media, Inc.
- Defense Industry Daily Staff. (2012, Dec 20). *C-40 Clippers Hitting Their Stride, Despite Past Controversy*. Retrieved Mar 4, 2013, from Defense Industry Daily: <http://www.defenseindustrydaily.com/c40-clippers-hitting-their-stride-despite-past-controversy-01559/>
- Department of Defense Instruction. (1998). *Patient Movement: DODI 6000.11, Sep. 9, 1998*. DOD.
- Department of Defense Instruction. (2012). *Patient Movement: Number 6000.11, May 4, 2012*. DOD.
- Diamond, M. (2003, September). *Aeromedical Evacuation Changes to Focus on Requirements*. Retrieved January 14, 2013, from Air Force Medicine: http://airforcemedicine.afms.mil/sg_newswire/sep_03/AEchanges.htm

- Duchateau, F.-X., Verner, L., Cha, O., & Corder, B. (2009). Decision Criteria of Immediate Aeromedical Evacuation. *Journal of Travel Medicine*, 391-394.
- Elliot, S. (2010, March 2). Aeromedical Evacuation. *Centennial of Military Aviation Newsletter*.
- Featherstone, R. L. (2009). *Determination of Critical Factors in Unmanned Casualty Evacuations in the Distributed Environment*. Naval Post-Graduate School, Navy. Monterey: Navy.
- Fortran. (n.d.). *The Fortran Company*. Retrieved January 30, 2013, from Fortran: <http://www.fortran.com/>
- geohack. (n.d.). Retrieved Jan 14, 2013, from Tool Server: <http://toolserver.org/~geohack/>
- Goodman, M. D., Makley, A. T., Lentsch, A. B., Barnes, S. L., Doriac, G. R., Dorlac, W. C., et al. (2010). Traumatic Brain Injury and Aeromedical Evacuation: When is the Brain Fit to Fly? *Journal of Surgical Research*, 286-293.
- Gross, D., Shortle, J. F., Thompson, J. M., & Harris, C. M. (2008). *Fundamentals of Queueing Theory*. Hoboken: John Wiley and Sons, Inc.
- Guerdan, B. R. (2011). United States Air Force Aeromedical Evacuation - Critical Disaster Response Resource. *American Journal of Clinical Medicine*, 153-156.
- Gulfstream. (2012). *G550: It's all in the details. Performance and Technology*. Gulfstream Aerospace Corporation.
- Gulfstream Aerospace Corporation. (2010). *G550 the most technologically advanced aircraft in its class*. Retrieved January 27, 2013, from gulfstream.com: http://gulfstream.vo.llnwd.net/o36/assets/pdf/brochures/g550/G550Specsheet_GS153E_V1.pdf
- Harman, D. R., Hooper, T. I., & Gackstetter, G. D. (2005). Aeromedical Evacuations from Operation Iraqi Freedom: A Descriptive Study. *Military Medicine*, 521-527.
- Health, Education, and Human Services Division. (1995). *Defense Health Care: Despite TRICARE Procurement Improvements, Problems Remain*. Washington D.C.: US General Accounting Office.
- Howard, W. G. (2003). *History of Aeromedical Evacuation in the Korean War and Vietnam War*. Fort Leavenworth, Kansas: U.S. Army Command and General Staff College.
- Howell, F. J., & Brannon, R. H. (2000). Aeromedical Evacuation: remembering the past, bridging to the future. *Military Medicine*, 429-33.
- Johnson Jr., A., Cooper, J. T., & Ellegood, F. E. (1976). Five-Year Study of Emergency Aeromedical Evacuation in the United States. *Aviation, Space, and Environmental Medicine*, 662-666.
- Kelton, W. D. (n.d.). *A Tutorial on Design and Analysis of Simulation Experiments*. Cincinnati: University of Cincinnati.

- Kelton, W. D., Sadowski, R. P., & Swets, N. B. (2010). *Simulation with Arena: Fifth Edition*. New York: McGraw-Hill.
- Kimminau, D. F. (1995). *Patient/Aircraft Forecasting for the Strategic Aeromedical Evacuation "Lift-Bed" Process*. Air Force Institute of Technology, Air Force . Wright-Patterson AFB: Air Force.
- Kneeland, R. A., Risio, A., Fulton, L., & Goodman, R. (2005). 421st Medical Evacuation Battalion History and Accolades. *Army Medical Department Journal*, 15-17.
- Kott, A., Saks, V., & Mercer, A. (1999). A New Technique Enables Dynamic Replanning and Rescheduling of Aeromedical Evacuation. *American Association of Artificial Intelligence*, 43-53.
- LINDO System INC. (2013). *Our Optimization Software*. Retrieved February 1, 2013, from LINDO Systems INC.: <http://www.lindo.com/>
- Loftus, M. J. (1993). *Patient Scheduling And Aircraft Routing For Strategic Aeromedical Evacuation*. AFIT.
- Mabry, E. W., Munson, R. A., & Richardson, L. A. (1993). The wartime need for aeromedical evacuation physicians: the U.S. Air Force experience during Operation Desert Storm. *Aviation, Space, and Environmental Medicine*, 941-946.
- Makley, A. T., Belizaire, R., Campion, E. M., Goodman, M. D., Sonnier, D. I., Friend, L. A., et al. (2012). Simulated Aeromedical Evacuation Does Not Affect Systemic Inflammation or Organ Injury in a Murine Model of Hemorrhagic Shock. *Military Medicine*, 911-916.
- Margolis, S. A., & Ypinazar, V. A. (2009). Aeromedical Retrieval for Critical Clinical Conditions: 12 Years of Experience with the Royal Flying Doctor Service, Queensland, Australia. *The Journal of Emergency Medicine*, 363-368.
- MathWorks. (2013). *Products & Services*. Retrieved February 1, 2013, from MathWorks: <http://www.mathworks.com/products/matlab/>
- McClain, D. R. (1988). *A Systems Approach To The Aeromedical Aircraft Routing Problem Using A Computer Based Model*. AFIT.
- Miles, O. G. (1990). *DUSTOFF: Aviation or Medical Evacuation?* Carlisle Barracks, PA: U.S. Army War College.
- Military Zone. (n.d.). *Information about US Military Installations*. Retrieved Jan 14, 2013, from Military Zone: http://themilitaryzone.com/military_bases.html
- Mitchell, R., Parker, J., Galarneau, M., & Konoske, P. (2010). Statistical Modeling of Combat Mortality Events by Using Subject Matter Expert Opinions and Operation Iraqi Freedom Empirical Results from the Navy-Marine Corps Combat Trauma Registry. *Journal of Defense Modeling and Simulation*, 145-155.
- Mullen, D. C. (June 1989). *A Dynamic Programming Approach to The Daily Routing of Aeromedical Evacuation System Missions*. Wright-Patterson AFB: AFIT.

- Nanney, J. S. (1998). *Army Air Forces Medical Services in World War II*. Washington D.C.: Air Force History and Museum Program.
- National Museum of the USAF. (n.d.). *Korean War: Aeromedical Evacuation*. Wright-Patterson AFB: National Museum of the USAF.
- O'Shea, B. (2011, October). Saving Lives on the Battlefield. *Military Medical/CBRN Technology*, pp. 8-11.
- Peyrad, T. (2011, November 11). *Distance between two points on Earth surface – Haversine formula*. Retrieved Jan 14, 2013, from Samoht: <http://samoht.fr/informatique/distance-between-two-points-on-earth-surface-haversine-formula>
- Reiter, B. L. (1993). *The History of Aeromedical Evacuation and the Emerging System of Tomorrow*. Washington D.C.: the Industrial College of Armed Forces.
- Ricks, M. (2011, May 14). *Critical care teams focus on safe returns*. Retrieved Oct 30, 2012, from Air Force Times: <http://www.airforcetimes.com/news/2011/05/air-force-critical-care-transport-teams-focus-on-safe-returns-051411w/>
- Rockwell Software. (n.d.). *Arena Simulation Software*. Retrieved Nov 19, 2012, from Arena Simulation Software: http://www.arenasimulation.com/Arena_Home.aspx
- Royal Flying Doctor Service. (2013). *Our History*. Retrieved January 30, 2013, from Flying Doctor: <http://www.flyingdoctor.org.au/About-Us/Our-History/>
- Sahoo, P. M. (n.d.). *Statistical Techniques for Spatial Data Analysis*. Retrieved Jan 25, 2013, from Indian Agricultural Statistics Research Institute : <http://www.iasri.res.in/ebook/EBADAT/6-Other%20Useful%20Techniques/11-Spatial%20STATISTICAL%20TECHNIQUES.pdf>
- SAS Institute Inc. (2013). *Statistical Discovery from SAS*. Retrieved Mar 4, 2013, from JMP: <http://www.jmp.com/>
- Shortle, J. F. (2008). *Fundamentals of Queueing Theory 4th Edition*. Retrieved January 27, 2013, from George Mason University: <http://mason.gmu.edu/~jshortle/fqt4th.html>
- USAF. (2 Oct 2009). *Air Mobility Operations, Joint Publication 3-17*.
- USAF. (31 July 2012). *Aeromedical Evacuation / En Route Care Capabilities-Based Assessment Report*. Scott AFB: Office of the Command Surgeon , Air Mobility Command.
- Walter, J., York, A., Thati, S., Niemtow, R., & Burns, S. (2012). The feasibility of integrating ear acupuncture into the aeromedical evacuation system from Ramstein Air Base (Germany) to Andrews Air Force Base (US). *BioMed Central Complement Alternative Medicine*, 114.
- Whetstone, W. T. (December 1988). *A Heuristic Approach for Aeromedical Evacuation System Scheduling and Routing*. Wright-Patterson AFB: AFIT.

- Wilhelm, S. A. (March 1998). *An Analytical Tool to Assess Aeromedical Evacuation Systems for the Department of Defense*. Wright-Patterson AFB: AFIT.
- Withers, M. R., & Christopher, G. W. (2000). Aeromedical evacuation of biological warfare casualties: a treatise on infectious diseases on aircraft. . *Military Medicine*, 165.

REPORT DOCUMENTATION PAGE			<i>Form Approved</i> <i>OMB No. 0704-0188</i>	
The public reporting burden for this collection of information is estimated to average 1 hour per response, including the time for reviewing instructions, searching existing data sources, gathering and maintaining the data needed, and completing and reviewing the collection of information. Send comments regarding this burden estimate or any other aspect of this collection of information, including suggestions for reducing this burden to Department of Defense, Washington Headquarters Services, Directorate for Information Operations and Reports (0704-0188), 1215 Jefferson Davis Highway, Suite 1204, Arlington, VA 22202-4302. Respondents should be aware that notwithstanding any other provision of law, no person shall be subject to any penalty for failing to comply with a collection of information if it does not display a currently valid OMB control number. PLEASE DO NOT RETURN YOUR FORM TO THE ABOVE ADDRESS.				
1. REPORT DATE (DD-MM-YYYY) 21-03-2013		2. REPORT TYPE Master's Thesis		3. DATES COVERED (From — To) May 2012-Mar 2013
4. TITLE AND SUBTITLE Urgent Aeromedical Evacuation Network Capacity Planning			5a. CONTRACT NUMBER	
			5b. GRANT NUMBER	
			5c. PROGRAM ELEMENT NUMBER	
6. AUTHOR(S) Finkbeiner, Scott C 2Lt USAF			5d. PROJECT NUMBER	
			5e. TASK NUMBER	
			5f. WORK UNIT NUMBER	
7. PERFORMING ORGANIZATION NAME(S) AND ADDRESS(ES) Air Force Institute of Technology Graduate School of Engineering and Management (AFIT/ENS) 2950 Hobson Way WPAFB OH 45433-7765			8. PERFORMING ORGANIZATION REPORT AFIT-ENS-13-M-04	
9. SPONSORING / MONITORING AGENCY NAME(S) AND ADDRESS(ES) Kurtis W. Faubion, Col, USAF, MSC Command Administrator 203 W Losey St Scott AFB, IL 62225 kurtis.faubion@us.af.mil DSN 779-6053			10. SPONSOR/MONITOR'S ACRONYM(S) AMC/SGS	
			11. SPONSOR/MONITOR'S REPORT NUMBER(S)	
12. DISTRIBUTION / AVAILABILITY STATEMENT APPROVED FOR PUBLIC RELEASE; DISTRIBUTION UNLIMITED				
13. SUPPLEMENTARY NOTES This material is declared a work of the U.S. Government and is not subject to copyright protection in the United States.				
14. ABSTRACT Aeromedical Evacuation (AE) has been steadily utilized during Operation Iraqi Freedom and Operation Enduring Freedom. AE is a global enterprise. The current structure of AE is facing changes as forces scale down from operations in Iraq and Afghanistan. AE will, however, continue to be important in its domestic use in the continental USA (CONUS). Current practice is to pull aircraft (e.g. C-17, C-130 or KC-135) from their normal operations to meet Urgent and Priority patient needs when local alternatives are infeasible. An alternative to the current system would be having a centralized "bed-down" location for AE operations that would house dedicated aircraft as well as AE personnel. In this thesis, a hybrid queuing and discrete-event simulation approach is used to determine how many aircraft are needed for a given level of AE patient care and an integer programming model is used to locate aircraft within the provider network. The high costs associated with operating current aircraft drive this research to look for solutions that better represent the future of Urgent and Priority patient movement operations whether CONUS or global.				
15. SUBJECT TERMS Aeromedical Evacuation, Dedicated, Urgent, Priority, Queueing, Discrete-Event Simulation				
16. SECURITY CLASSIFICATION OF:			17. LIMITATION OF ABSTRACT UU	18. NUMBER OF PAGES 81
a. REPORT U	b. ABSTRACT U	c. THIS PAGE U		19a. NAME OF RESPONSIBLE PERSON Dr. Jeffery K. Cochran, PhD, AFIT/ENS
			19b. TELEPHONE NUMBER (Include Area Code) (937)255-3636, ext 4521	

Standard Form 298 (Rev. 8-98)
Prescribed by ANSI Std. Z39.18